

# Valves, Cylinders & Production Equipment Catalog

 We make things **MOVE**®



## We Make Things Move®

A forward-thinking innovator, Bimba provides industry-leading pneumatic, hydraulic and electric motion solutions that are easy-to-use, reliable and ready for your engineering challenges.

Doing whatever it takes to help you get the job done is what the Bimba companies do best. With an extensive line of industry-leading air cylinders, rotary actuators, linear thrusters, rodless cylinders, NFPA, hydraulics, flow controls, position-sensing cylinders, valves, switches and air preparation equipment, the people of Bimba are ready to tackle your toughest applications.

Bimba is part of IMI Precision Engineering, a world leader in motion and fluid control technologies. Wherever precision, speed and engineering reliability are essential, we deliver exceptional solutions which improve the productivity and efficiency of customers' equipment.

Our range of high-performance products, such as actuators, valves, valve islands, pressure monitoring controls and air preparation products together with trusted products brands including IMI Norgren, IMI Buschjost, IMI FAS, IMI Herion and IMI Maxseal underpin our position as a leading global supplier.

Part of IMI plc, we have a sales and service network in 75 countries, as well as manufacturing capability in the USA, Germany, China, UK, Switzerland.

## Contents

---

**02** Introduction

---

**03** Control Valves

---

**43** Cylinders

---

---

**81** Specialty Valves

---

**99** Production Devices

---

**109** Accessories

---

---

**116** Reference

---

# Control Valves

Control Valves help you modulate your media flow. A variety of power options, including air, solenoid, and manual/mechanical, provide flexibility to adapt to your pneumatic system. Unique valve styles and the ability to integrate many control valves into manifold systems offer additional possibilities for you to get the most out of your machines.

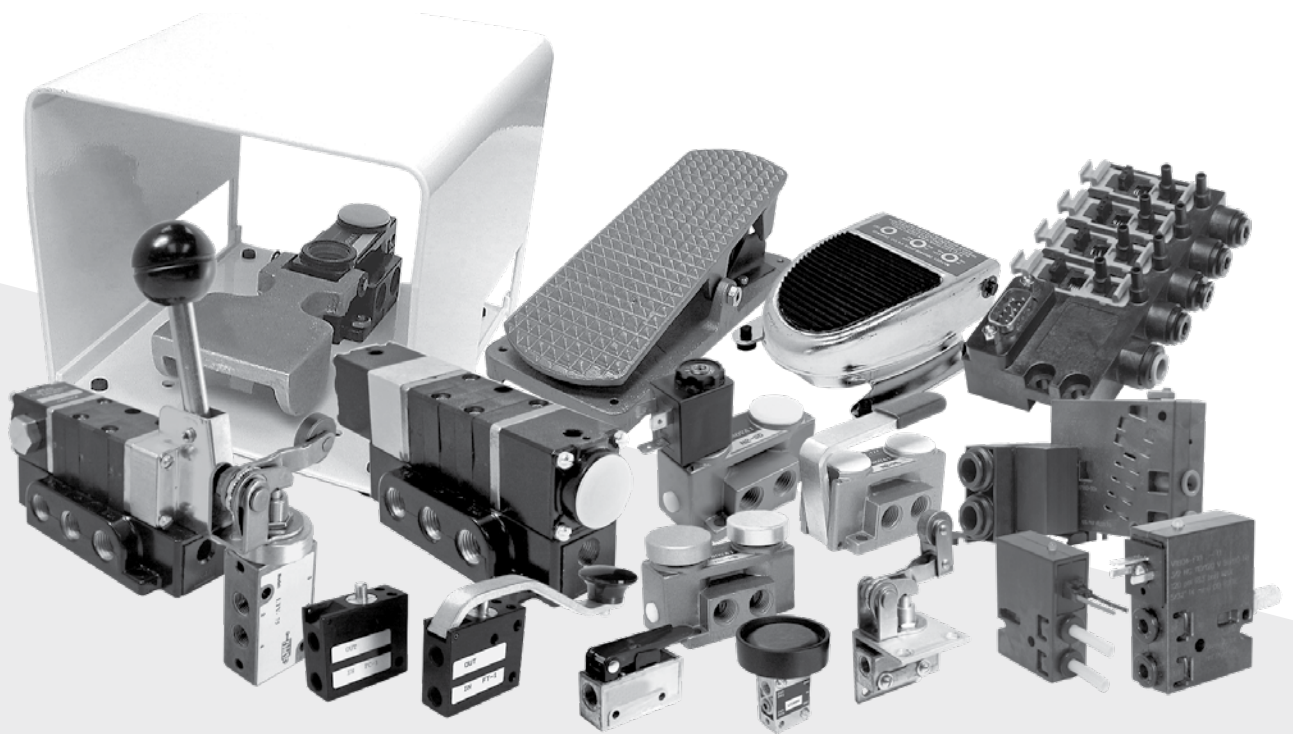

# Contents

- 
- 5** Isonic® V Series Control Valves
- 
- 6** Isonic® V1000 Series  
6 – Engineering Specs  
7 – Valve & Manifold Dimensions  
8 – Accessories & Electrical Connectors  
9 – How To Order
- 
- 10** Isonic® V2000 Series  
10 – Engineering Specs  
12 – Accessories & Electrical Connectors  
13 – How To Order
- 
- 14** Isonic® V4000 Series  
14 – Engineering Specs  
15 – Dimensions & Manifold Specs  
16 – How To Order
- 
- 17** Manifold Powerstrip™  
17 – Engineering Specifications  
17 – Valve Compatibility  
18 – Accessories  
19 – Dimensions  
19 – How To Order
- 
- 20** Nova Series Control Valves  
21 – Engineering Specifications  
22 – Connectors, Options, Dimensions  
23 – How To Order
- 
- 24** Capsula Series Control Valves  
24 – Engineering Specifications  
25 – Connectors, Models, Dimensions  
23 – How To Order
- 
- 27** Dura-Matic Series Control Valves  
27 – Technical Data  
28 – Valve Types & Dimensions  
28 – How To Order
- 
- 29** Ergonomic Low Stress Air Control Valves  
29 – Technical Data  
30 – Mounting Options & Dimensions  
30 – How To Order
- 
- 31** LTV Series Control Valves  
31 – Technical Data  
33 – Connectors, Stacks & Flow Patterns  
33 – Dimensions  
34 – How To Order
- 
- 35** MV Series Switches  
35 – Technical Data  
37 – How It Works, Fittings & Dimensions  
38 – How To Order
- 
- 39** General Purpose Valves  
39 – Technical Data  
40 – Spool Types & Flow Patterns  
40 – Dimensions  
41 – How To Order
-

## Product Information

### The Award-Winning “Half-Shell” Design

The heart of the Isonic® concept is its patented “half-shell” design. Composed of two mirror-image halves, Isonic® allows its flow channels and internal component compartments to be designed directly into these molded body sections. Valve bodies are molded of high-strength, glass-impregnated Ultem thermoplastic.

Assembly is achieved by simply inserting the various valve elements into their corresponding “half-shell” pockets. Internal components are easily positioned to make optimal use of space.

The valve is completed by ultrasonically welding the two valve segments, creating a strong bond and hermetic seal. This design totally eliminates the need for fasteners, adhesives, gaskets and inserts.

### Revolutionary Valve Production

Isonic® technology eliminates all machining operations associated with valve manufacturing. Requiring only simple assembly, Isonic® can be produced quickly and easily with significant cost reduction.

### Design Optimizes Valve Performance

Isonic® 2, 3 and 4-way valves feature a unique, multi-patented design that significantly shrinks valve size while boosting flow capacity. With its design and a state-of-the-art manufacturing process, Isonic® breaks through the restriction and limitations of conventional valve manufacturing.

### Loaded with Standard Features

Along with its size and price advantages, Isonic® offers numerous user features, many of them standard. Most models feature an integral electronic board with surge suppression and LED. A variety of voltages and wiring options are available. This combination of price and versatility makes Isonic® the perfect control choice for pneumatic systems.

### Faster Manifold Connections

The Isonic® manifold system has been designed to virtually eliminate downtime, eliminating all end plates, screws, o-rings and gaskets customarily found in manifold systems. Connecting any valve to the manifold base is as easy as plugging in an electrical cord. With this patented “plug-in” design, replacing an individual valve can be accomplished in seconds, without the aid of any tools!

Available in two, three, four or five station segments, the Isonic® manifold’s unique modular design creates a versatile, expandable control base. For larger manifolds, two or more segments can be easily combined to fulfill any needs. Further, manifold segments are easily isolated for applications with differential pressures.

### Quick-Connect Collets - No Fittings Needed

With its unique design Isonic® eliminates the need for tube fittings. Built-in, push-to-connect collets allow for fast and easy tube and manifold connections.

### Resistant To Harsh Conditions

Molded from a high performance thermoplastic, Isonic® achieves superior heat, impact and chemical resistance. It is listed with both UL and CSA.

### Maximum Air Flow

Instead of the angular passages of most conventional valves, Isonic’s internal channels are aerodynamically shaped for maximum air flow and minimal internal friction. Eliminating sharp corners and abrupt changes in direction reduces air turbulence and energy loss. Normally round air passages are replaced by thin, deep, tape-like channels that conserve space and optimize air flow.

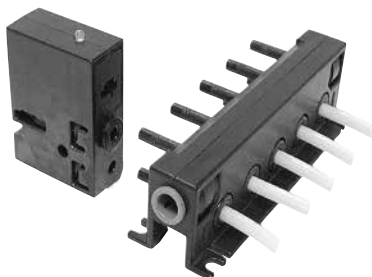

**V1000 Series**  
2 & 3 way

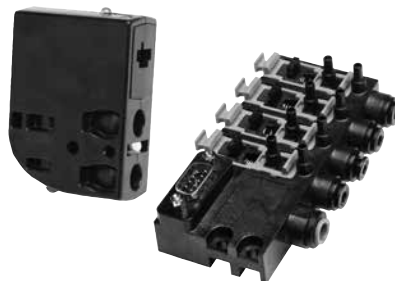

**V2000 Series**  
2 & 3 way



**V4000 Series**  
4 way

Isonic® V1 and V4 have earned UL recognition and have been tested to the standards of CSA and conforms to the applicable directives of the European Union.



Isonic® is a registered trademark of Bimba

# Product Features

## Technical Data

### Engineering Specifications

<b>Design</b>	Poppet
<b>Media</b>	Air or Inert Gas
<b>Lubrication</b>	None Required
<b>Filtration</b>	40 Micron
<b>Orifice Size</b>	A: 0.025" / 0.65mm B: 0.035" / 0.90mm C: 0.055" / 1.4mm
<b>Flow</b>	A: 0.01 C <sub>v</sub> B: 0.02 C <sub>v</sub> C: 0.05 C <sub>v</sub>
<b>Maximum Pressure</b>	A: 120 PSI / 8.3 Bar B: 120 PSI / 8.3 Bar C: 30 PSI / 2.1 Bar
<b>Vacuum</b>	to 28 in. Hg
<b>Temperature Range</b>	0° F to 120° F (-18° C to 49° C)
<b>Tubing</b>	5/32" or 4mm
<b>Mounting Holes</b>	0.156 diameter (1 hole, 1 slot)
<b>Seals</b>	Viton® and Nitrile
<b>Weight</b>	1.5 oz. (per valve)

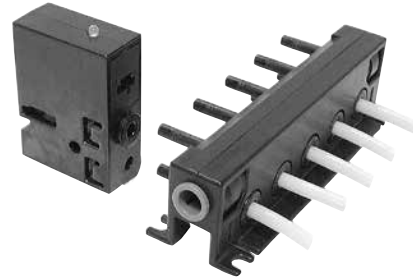

### Solenoid Data

Voltage	12DC	24DC	24AC	120AC
Amps	0.133	0.058	0.058	0.014
Resistance	92Ω	406Ω	406Ω	8350Ω
Initial Power	1.6w	1.4w	1.4w	1.7w
Continuous On	1.3w	1.2w	1.2w	1.5w

Response Time	Din Connector
10 milliseconds	Protection Class- IP 65 according to DIN 40 050 Insulation Class- Group C according to VDE 0110 Conform to DIN 43650 Form C Specifications

### Manifold

Common Air Inlet	Foot Mounting	DIN Rail Mounting
Built-in, push-in fittings for 1/4" OD or 6mm tubing both ends	4 slots, 11/16" diameter	Attaches to 15mm DIN rail

## Product Information

### Dimensions

#### Valves

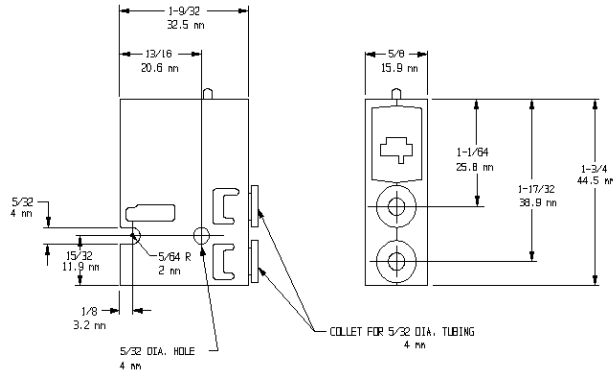
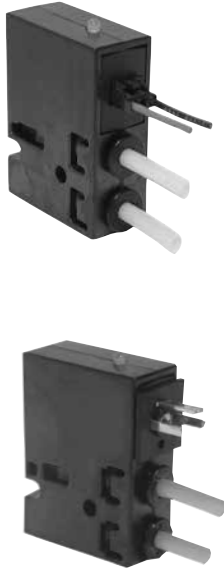

#### Manifolds

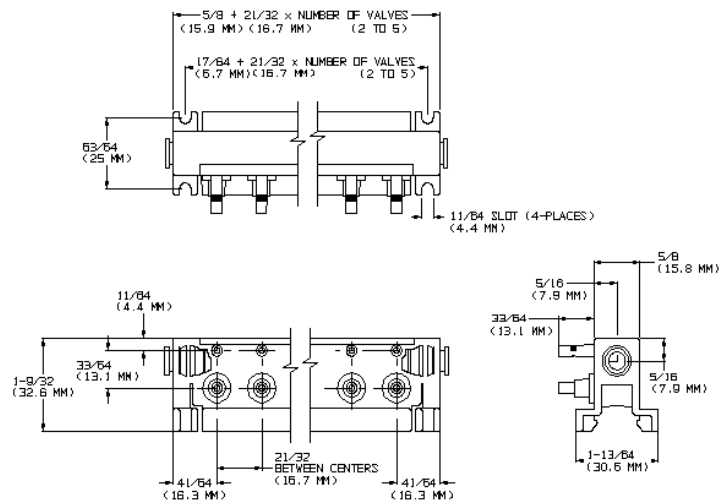

# How To Accessorize

## Product Information

### Accessories



P1SA1



P1SA2



P1Q1

NOTE: One (1) pc. is included with each "W" type valve. 24 AWG wire.

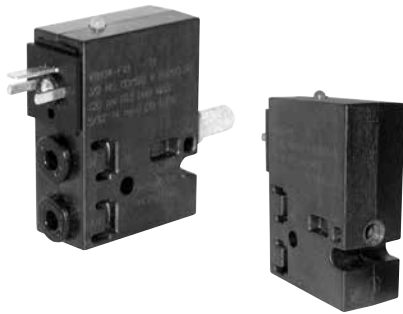

MM-019

Muffler shown here on V1 Valve with T1 option

### Electrical Connectors

8mm Micro DIN Connector	8mm Micro DIN Connector (molded, pre-wired)	Mini Quick-Connect
P1D1	P1D2 (includes 39" / 1m leads)	P1Q1 (includes 18" / 45cm leads; contact factory for longer lengths)

### Manifold Accessories

15mm DIN Mounting Rail	15mm DIN Rail End Stops	4 mm (5/32") Manifold Blocking Plug	1/4" Manifold Inlet Port Plug	6mm Manifold Inlet Port Plug
P1M1-x (where x = desired number of feet of DIN Rail)	P1S1 (NOTE: two required per Manifold)	P1B1 (for blocking empty Manifold stations)	P1P1 (one included with each manifold)	P1P2 (one included with each manifold)

### Miscellaneous

10-32 Muffler	Port Adapter	Port Adapter
MM-019 (to silence exhaust in 10-32 exhaust port)	P1SA1 (converts 5/32" port to 1/4" barb OD tube)	P1SA2 (converts 5/32" port to 1/4" push-to-connect OD tube)



## How To Order

### Valves

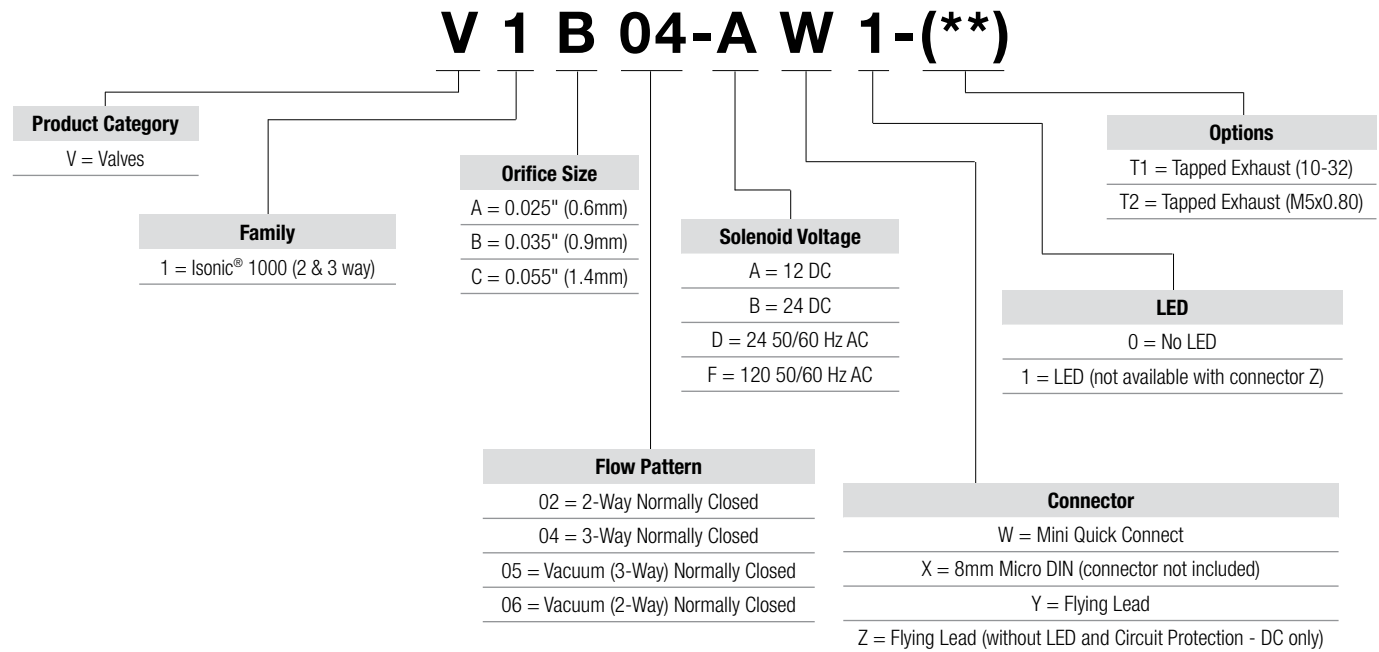

### Valve Symbols

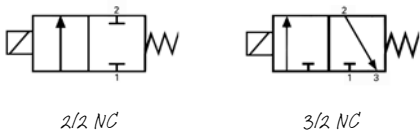

### Manifold

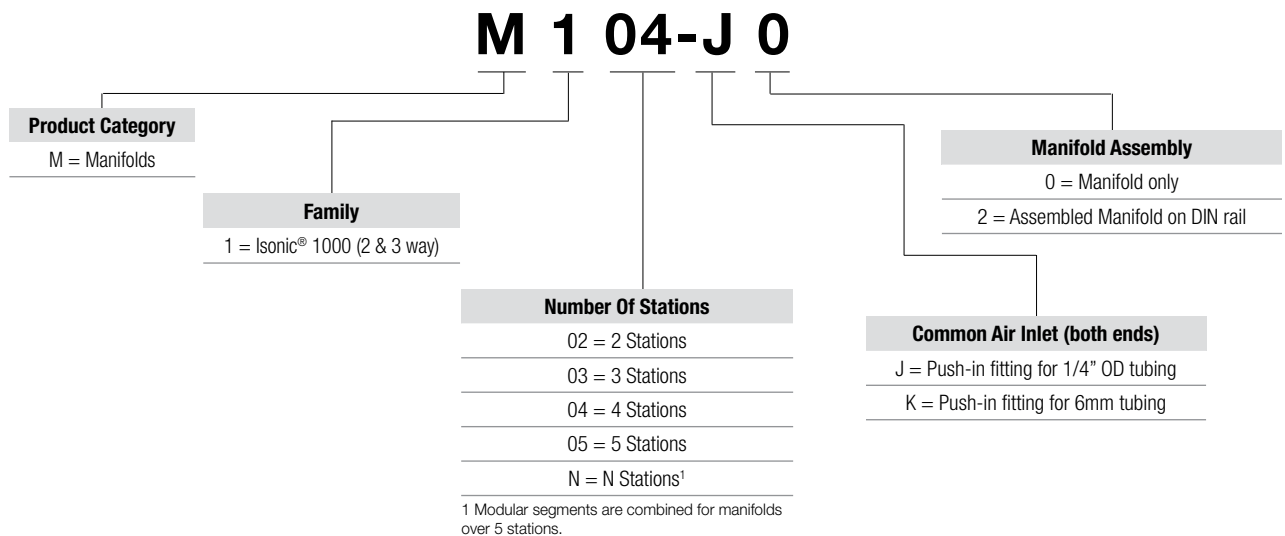

# Product Features

## Technical Data

### Engineering Specifications

	Normally Closed Version	Normally Open Version
<b>Design</b>	Direct Acting	Direct Acting
<b>Media</b>	Air or Inert Gas	Air or Inert Gas
<b>Lubrication</b>	None Required	None Required
<b>Filtration</b>	40 Micron	40 Micron
<b>Cycle Life</b>	50,000,000 cycles	10,000,000 cycles (standard power) 50,000,000 cycles (low power)
<b>Orifice Size</b>	A: 0.025" / 0.65mm B: 0.035" / 0.90mm C: 0.055" / 1.4mm	B: 0.035" / 0.90mm C: 0.055" / 1.4mm <sup>1</sup>
<b>Flow</b>	A: 0.01 C <sub>v</sub> B: 0.02 C <sub>v</sub> C: 0.05 C <sub>v</sub>	B: 0.02 C <sub>v</sub> C: 0.05 C <sub>v</sub>
<b>Max Pressure (Standard Power)</b>	A: 120 PSI / 8.3 Bar B: 120 PSI / 8.3 Bar C: 30 PSI / 2.1 Bar	B: 90 PSI / 6.2 Bar C: 25 PSI / 1.6 Bar
<b>Max Pressure (Low Power)</b>	A: 45 PSI / 3 Bar B: 45 PSI / 3 Bar	B: 37 PSI / 2.5 Bar
<b>Vacuum</b>	to 28 in. Hg	to 28 in. Hg
<b>Temperature Range</b>	0° F to 120° F (-18° C to 49° C)	0° F to 120° F (-18° C to 49° C)
<b>Tubing</b>	5/32" or 4mm	5/32" or 4mm
<b>Mounting Holes</b>	0.156 diameter (2 holes)	0.156 diameter (2 holes)
<b>Seals</b>	Viton® and Nitrile	Viton® and Nitrile
<b>Weight</b>	1.5 oz. (per valve)	1.5 oz. (per valve)

<sup>1</sup> Standard Power Only



### Solenoid Data

Voltage	12DC	24DC	24AC	120AC
Amps	0.133	0.058	0.058	0.014
Resistance	92Ω	406Ω	406Ω	8350Ω
Initial Power	1.6w	1.4w	1.4w	1.7w
Continuous On	1.3w	1.2w	1.2w	1.5w

Response Time	Din Connector
10 milliseconds	Protection Class: IP 65 according to DIN 40 050 Insulation Class: Group C according to VDE 0110 Conform to DIN 43650 Form C Specifications

### Manifold

Common Air Inlet	Rear Mounting	DIN Rail Mounting
Built-in, push-in fittings for 1/4" OD or 6mm tubing	2 Holes for M4 screws	Attaches to 35mm DIN rail

## Product Information

### Dimensions

#### Valves

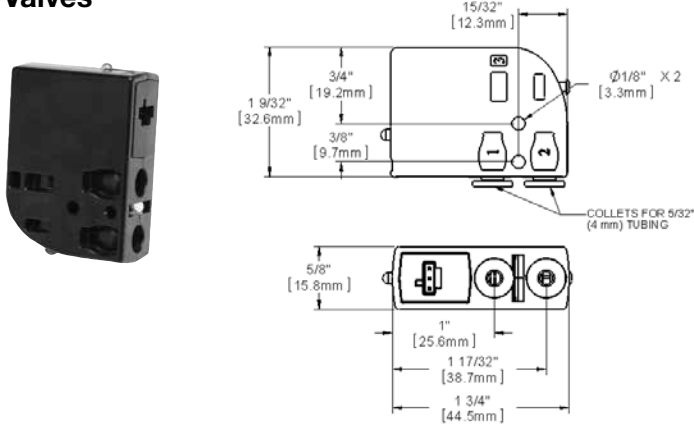

#### Manifold Connector Wiring

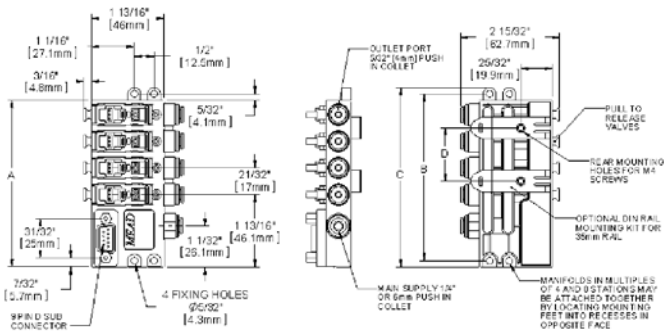

Manifold	A	B	C	D
4 Station	4-3/16 [106.3]	4-3/16 [106.3]	4-1/2 [114.3]	1-11/32 [34]
8 Station	6-7/8 [174.3]	6-7/8 [174.3]	7-13/32 [188.3]	4-1/32 [102]

Note: Dimensions in inches [mm]

#### Manifold Wiring Diagram

First numbers are the pin numbers. Center information refers to station. Colors are the wire color of Bimba accessories.

9-Pin Sub-D Connector  
(4 Station Manifold Only)

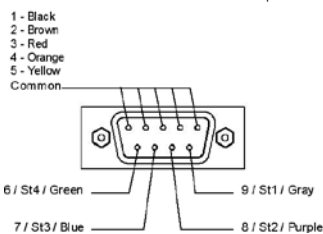

9-Pin Sub-D Connector  
(8 Station Manifold Only)

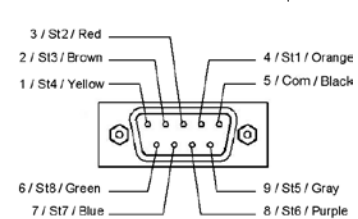

# How To Accessorize

## Product Information

### Accessories



P2B1



P4M1-x



P5-09SCD



P1SA1



P1SA2



P1Q1

NOTE: One (1) pc. is included with each "W" type valve. 24 AWG wire.



P4S1

### Electrical Connectors

8mm Micro DIN Connector	8mm Micro DIN Connector (molded, pre-wired)	Mini Quick-Connect
P1D1	P1D2 (includes 39" / 1m leads)	P1Q1 (includes 18" / 45cm leads; contact factory for longer lengths)

### Manifold Accessories

35mm DIN Mounting Rail	35mm DIN Rail End Stops	Manifold Blocking Plug	5.0m Cable and 9 Pin Connector
P4M1-x (where x = desired number of feet of DIN Rail)	P4S1 (NOTE: two required per Manifold)	P2B1 (for blocking empty Manifold stations)	P5-09SCD

### Miscellaneous

10-32 Muffler	Port Adapter	Port Adapter
MM-019 (to silence exhaust in 10-32 exhaust port)	P1SA1 (converts 5/32" port to 1/4" barb OD tube)	P1SA2 (converts 5/32" port to 1/4" push-to-connect OD tube)

## How To Order

### Valves

**V 2 B 04-B W 1-L-T1**

**Product Category**  
V = Valves

**Family**  
1 = Isonic® 2000 (2 & 3 way)

**Orifice Size**  
A = 0.025" (0.6mm)<sup>1</sup>  
B = 0.035" (0.9mm)  
C = 0.055" (1.4mm)<sup>2</sup>

<sup>1</sup> Only available on Normally Closed.  
<sup>2</sup> Not available with Low Power option.

**Solenoid Voltage<sup>3</sup>**  
A = 12 VDC  
B = 24 VDC  
D = 24 50/60 Hz AC  
F = 120 50/60 Hz AC  
R = 5 VDC  
M = 3 VDC

<sup>3</sup> See Option Combination Availability chart below.

**Options**  
L = Low Power<sup>4</sup>  
T1 = Tapped Exhaust (10-32)  
T2 = Tapped Exhaust (M5x0.80)  
<sup>4</sup> See Option Combination Availability chart below for voltage options.

**LED**  
0 = No LED (only available with connector Z)  
1 = LED (not available with connector Z)

**Flow Pattern**  
02 = 2-Way Normally Closed  
03 = 3-Way Normally Open  
04 = 3-Way Normally Closed  
05 = Vacuum (3-Way) Normally Closed  
06 = Vacuum (2-Way) Normally Closed  
07 = Vacuum (3-Way) Normally Open

**Connector**  
W = Mini Quick Connect  
X = 8mm Micro DIN (connector not included)  
Y = Flying Lead  
Z = Flying Lead (without LED and Circuit Protection - DC only)

### Valve Symbols

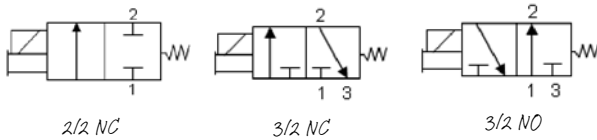

### Option Combination Availability

Voltage	Standard Power 1.5W, 8 Bar	Low Power (L option) 0.5W, 3 Bar
3 VDC		•
5 VDC		•
12 VDC	•	•
24 VDC	•	•
24 VAC	•	
120 VAC	•	

### Manifold

**M 2 B 08-1 1**

**Product Category**  
M = Manifolds

**Family**  
2 = Isonic® 2000 (2 & 3 way)

**Inlet Tube Size**  
A = 1/4" OD Tube Collets  
B = 6mm OD Tube Collets

**Number Of Stations**  
04 = 4 Stations  
08 = 8 Stations

**Options**  
0 = No cable or connector  
5 = With 5.0m cable and connector

**Manifold Assembly**  
0 = Manifold only  
1 = DIN rail clips mounted on manifold  
2 = Manifold mounted on DIN rail

# Product Features

## Technical Data

### Isonic® Control Valves

While only 20mm in width, these 2 position spool valves provide a surprisingly high flow ( $C_v = 0.8$ ). With its thin, aerodynamic flow passages, Isonic® maintains a higher flow in a smaller area. The pilot piston features an innovative oval design to further facilitate a compact, low-profile power valve.

### Versatile Mounting

With a hole and a slot molded into its body, Isonic® valves may be mounted flush to any flat surface. Mounting brackets are also available for individual surface or DIN rail mounting.



## Engineering Specifications

<b>Design</b>	Spool (2-Position)
<b>Ports</b>	1/4" OD tube collet or 6mm OD tube collet
<b>Pilot Ports</b>	5/32" (4mm) OD tube collet
<b>Media</b>	Air or Inert Gas
<b>Lubrication</b>	None Required
<b>Filtration</b>	40 Micron
<b>Orifice Size</b>	0.2" / 5.0mm
<b>Flow</b>	0.8 $C_v$
<b>Minimum Pressure</b>	30 PSI / 2 Bar
<b>Maximum Pressure</b>	120 PSI / 8.3 Bar
<b>Vacuum</b>	Air pilot models can be used in vacuum applications with external air signal to pilot ports
<b>Temperature Range</b>	0° F to 120° F (-18° C to 49° C)
<b>Mounting Holes</b>	0.177 diameter (4.5mm) diameter (1 hole, 1 slot)
<b>Weight</b>	Solenoid models: 3.1 oz each Air Pilot models: 2.1 oz each

## Solenoid Data

<b>Voltage</b>	<b>12DC</b>	<b>24DC</b>	<b>24AC</b>	<b>120AC</b>
Amps	0.133	0.058	0.058	0.014
Resistance	92Ω	406Ω	406Ω	8350Ω
Initial Power	1.6w	1.4w	1.4w	1.7w
Continuous On	1.3w	1.2w	1.2w	1.5w

### Materials

Body	GE thermoplastic
Seals	Fluorocarbon and Nitrile

### Electrical

Voltages	DC: 12, 24 AC: 24, 110/120
Leads	18" standard - 24 AWG wire
Duty Cycle	Continuous duty
Response Time	16 milliseconds @ 100 PSI
Manual Override	Standard (solenoid models)

Protection Class- IP 65 according to DIN 40 050  
Insulation Class- Group C according to VDE 0110  
Conform to DIN 43650 Form C Specifications.



## Product Information

### Dimensions (mm)

#### Valves

##### Pressure Piloted Models

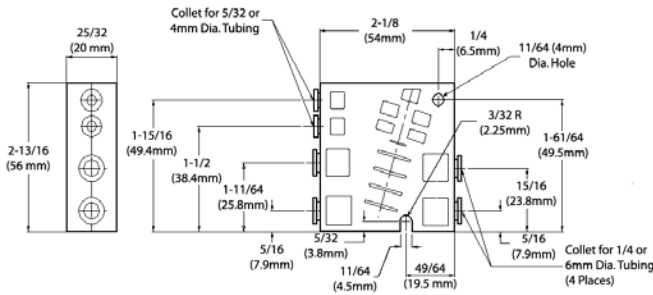

##### Solenoid Operated Models

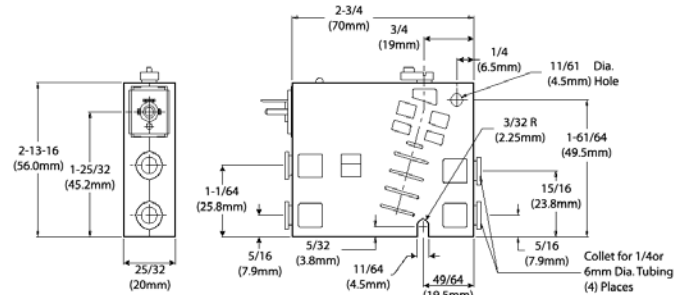

#### Function

\* Arrow Indicates Pressure applied to Pilot Port

- 1 = Air Supply
- 2 = Cylinder
- 3 = Common Exhaust
- 4 = Cylinder

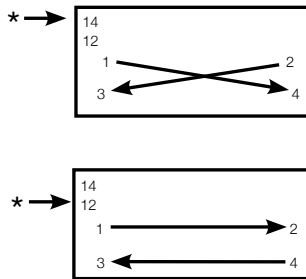

#### Function

- 1 = Air Supply
- 2 = Cylinder
- 3 = Common Exhaust
- 4 = Cylinder

##### Unactuated

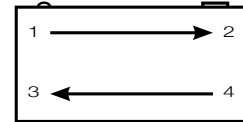

##### Actuated

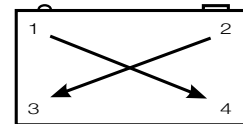

### V4 Manifolds

#### The Quick-Change Manifold

The Isonic® manifold system has been designed to virtually eliminate downtime. Connecting any valve to the manifold base is as easy as plugging in an electrical cord. With this patented “plug-in” design, replacing an individual valve on the manifold can be accomplished in a matter of seconds!

The Isonic® manifold can be either foot mounted or DIN rail mounted. 35mm DIN rail can be ordered from Bimba.

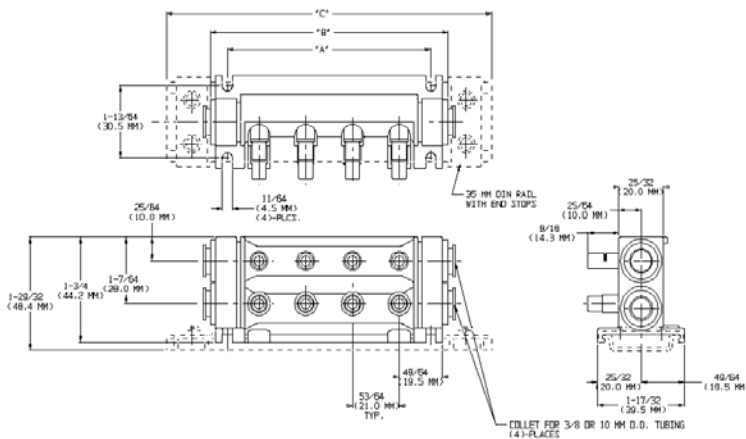

#### Mounting Options

The Isonic® manifold can be either foot mounted or DIN rail mounted. 35mm DIN rail can be ordered from Bimba.

#### Isonic® Manifold Expands With Your Needs

Available in two, three or four station segments, the manifold's unique modular design creates a versatile, expandable control base. For manifolds larger than four stations, two or more segments can be easily combined to create any size manifold (multiple segments are assembled on DIN rail and secured with end stops). Manifold segments are easily isolated for applications with differential pressures.

#### Manifold Specifications

	Common Air Inlet	Foot Mounting	DIN Rail Mounting
	Both ends: built in collets for 3/8" OD (or 10mm) tubing	0.177 (4.5 mm) diameter	Attaches to 35 mm DIN rail
Stations	"A"	"B"	"C"
2	1-61/64 (49.5 mm)	2-35/64 (64.7 mm)	4-9/64 (105 mm)
3	2-25/32 (70.5 mm)	3-3/8 (85.6 mm)	4-15/16 (125 mm)
4	3-39/64 (91.5 mm)	4-13/64 (106.7 mm)	5-49/64 (146 mm)
5	5-9/64 (130.5 mm)	5-57/64 (149.6 mm)	7-19/64 (185 mm)
6	5-31/32 (151.5 mm)	6-9/16 (166.7 mm)	8-1/8 (206 mm)
7	6-51/64 (172.5 mm)	7-25/64 (187.7 mm)	8-61/64 (227 mm)
8	7-5/8 (193.5 mm)	8-7/32 (208.7 mm)	9-25/32 (248 mm)

# How To Order

## How To Order

### Valves

# V 4 A-0307-A W 1-(\*\*)

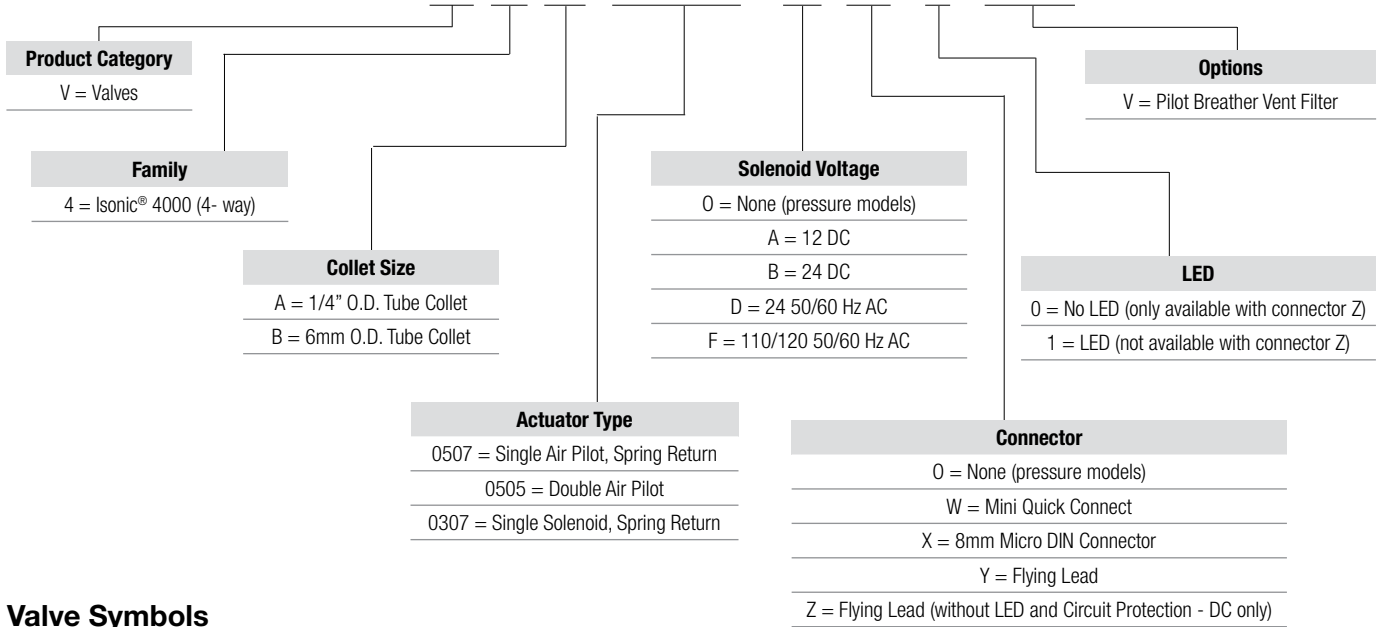

### Valve Symbols



4/2 Double Air Pilot

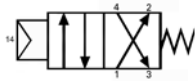

4/2 Single Air Pilot

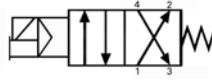

4/2 Single Solenoid

### Manifold

# M 4 A 03-2 Y

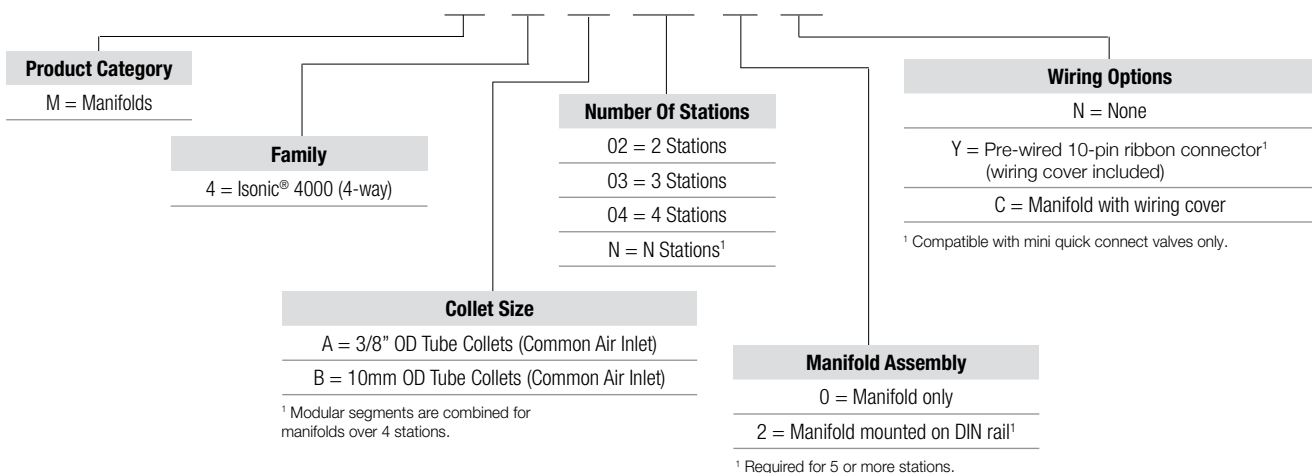



## Features & Benefits

### Simple, Cost Effective Manifold Wiring

Bimba's Manifold PowerStrip™ (MPS) offers a simple solution to wiring manifold valve stacks. The MPS reduces installation time, simplifies troubleshooting, and provides a clean, space-efficient alternative to individual wiring and costly molded cable sets.

- > Simplify Wiring
  - » Eliminates bundled wire sets with a single home-run cable
- > Reliable Design
  - » IP65 ingress protection
  - » Ultrasonic-welded construction
  - » Non-metallic, corrosion resistant
- > Cost Effective
  - » Reduce installation time
  - » Replaces individually wired DIN connectors and molded cable sets

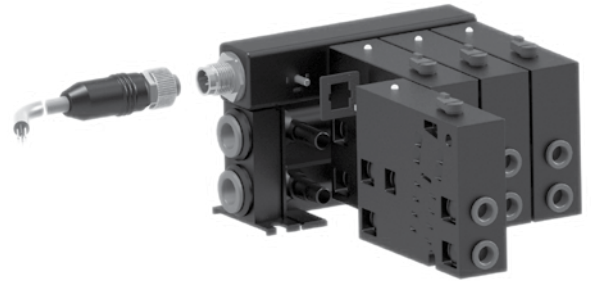

## Technical Data

### Engineering Specifications

<b>Compatibility</b>	Isonic® V4000 Series
<b>Voltage Range</b>	0-120 VAC/VDC
<b>Temperature Range</b>	0° F to 120° F ambient (-18° C to 49° C)
<b>Maximum Coil Power</b>	2W
<b>Electrical Connection</b>	5-Pin M12 Male
<b>Enclosure Rating</b>	IP65
<b>Body Material</b>	ABS

### Valve Compatibility

Valve Series	Manifold	Manifold PowerStrip™
V4_-0307-_X1-_	M4_--_N	MPS5-_-_-

### Product Contents

Model	Includes
MPS5-_-	Manifold PowerStrip™, Screws, Gaskets
MPS5-_-C10	Manifold PowerStrip™, Screws, Gaskets, 10m M12 Cable

# How To Order

## How To Order

### Dimensions (mm)

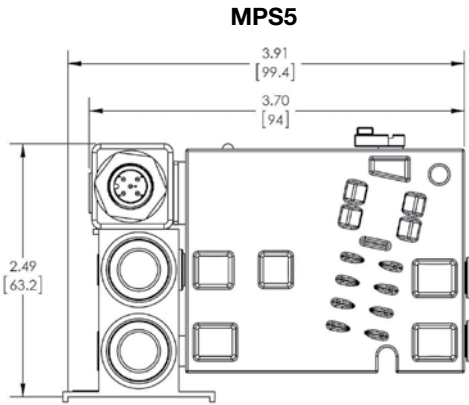

### Wire Connector Dimensions

#### Wiring Diagram

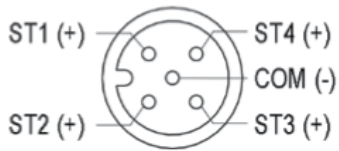

#### 10m M12 Cable

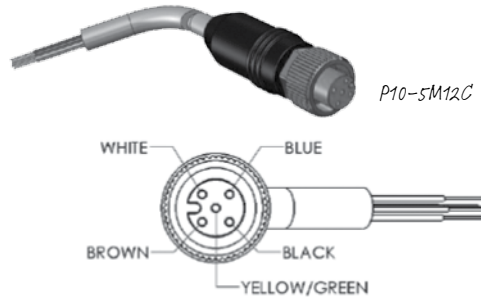

## MPS 5-4-C10

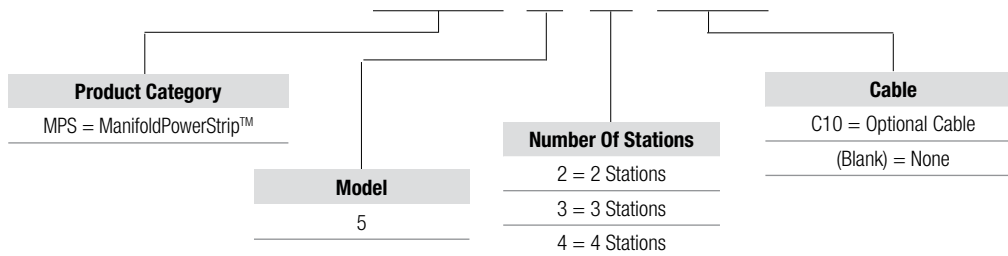

## Product Information

### Accessories

Electrical Connectors	
8mm Micro DIN Connector	P1D1
8mm Pre-wired DIN Connector (includes 39" leads)	P1D2
Mini Quick-Connect (includes 18" leads)	P1Q1
D-Sub Connector 9-Pin with 5 Meter Cable	P5-09SDC
D-Sub Connector 15-Pin with 3 Meter Cable	P3-15SDC
D-Sub Connector 15-Pin with 10 Meter Cable	P10-15SDC

Mounting Brackets (For 4-Way Valves Only)	
Single Valve Mounting Bracket	P4SM
Single Valve DIN Rail Mount	P4DM

Port Adapter (For 5/32" Ports)	
Converts Port to Barb for 1/4" OD Tube	P1SA1
Converts Port to Push-in Fitting (1/4" OD Tube)	P1SA2

DIN Rail & Manifold End Stops	
35mm DIN Rail for V2000/V4000 (x = # of feet required)	P4M1-x
15mm Rail End Stop for V1000	P1S1
35mm Rail End Stop V2000/V4000	P4S1

Manifold Station Blocking Plugs & Port Plugs	
5/32" (4mm) Station Plug (for empty manifold stations)	P1B1
Blanking Plug for V2000 Manifolds	P2B1
1/4" Station Plug (for empty manifold stations)	P4B1
6mm Station Plug (for empty manifold stations)	P4B2
1/4" Port Plug	P1P1
6mm Port Plug	P1P2
3/8" Port Plug	P4P1
10mm Port Plug	P4P2

Miscellaneous Accessories (for 4-Way Valves Only)	
Valve Locking Clip (locks 2 valves in place)	P4LC-2
Valve Locking Clip (locks 3 valves in place)	P4LC-3
Valve Locking Clip (locks 4 valves in place)	VP4LC-4

Tube Collets (For Replacement Only)	
For 5/32" (4mm) Port	P1C1
For 1/4" Port	P4C1
For 6mm Port	P4C2
For 3/8" Port	P4CA
For 10mm Port	P4CB

Push-In Exhaust Mufflers	
For 1/4" Port	MMP-250
For 6mm Port	MMP-006
For 3/8" Port	MMP-375
For 10mm Port	MMP-010
For 10-32 Port	MM-0019



P1SA2



P4S1



P4M1-x



P4C1 & P4CA



P2B1



P5-09SDC



P1Q1



P1SA1



P4LC-4



MMP-250

### Wiring Connector Dimensions

Mini Quick-Connect - 24 AWG wires

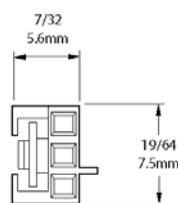
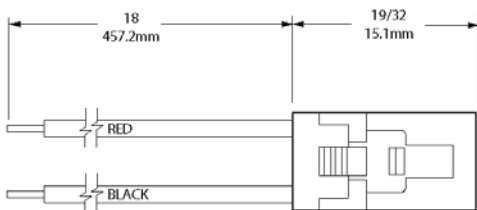

8mm DIN Connector

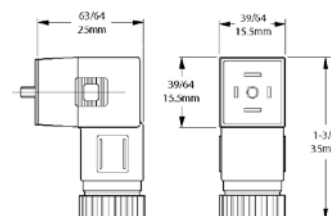

# Product Features

## Features & Benefits

### Designed For Long Life

Nova 4-way directional control valves offer state-of-the-art air valve design at a remarkably low price. Nova utilizes a single bonded rubber spool with finely ground sealing lands that travel only .047"… less than 1/16th of an inch! This economy of movement assures long valve life yet generates enough flow to power a 4" bore cylinder.

### Large Air Flow With Dual Exhausts

1/4" NPTF ported Nova valves produce a large output flow of 57 cubic feet per minute at 100 PSI inlet pressure (Cv=1.0). Each output port has its own exhaust port so that individual exhaust control is possible.

### Manual Override as Standard

All Nova valves are supplied with manual overrides so that valve actuation may be triggered without electricity or air to the pilots.

### External Pilot Option (E)

For solenoid actuation below the stated minimum pilot pressure or for vacuum applications, a 10-32 tapped external air supply allows the solenoid to be operated at different pressures than the power section.

### Easy to Repair

Nova valves are designed to permit complete replacement of all wearing parts in seconds without touching the piping or electrical wiring. All you need are a pair of snap ring pliers and a replacement spool.

### Single and Double Air Piloted



N1-SP  
N2-SP



N1-DP  
N2-DP

### Single and Double Solenoid



N1-SCD  
N2-SCD



N1-DCD  
N2-DCD

Solenoids shown here with PVD1 (sold separately)

### Double Push Button



N1-PB  
N2-PB

### Hand Lever



N1-HL  
N2-HL

### Foot Pedal

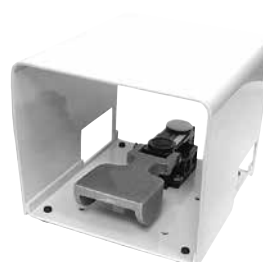

N1-F4  
N2-F4

## Technical Data

### Engineering Specifications

N1 Model	N2 Model	Actuator	Return	Description	Min. Pilot Pressure	Available Voltages		Wiring Type
						DC	AC	
N1-DP	N2-DP	Air Pilot	Air Pilot	Double Pressure Piloted	10 PSI	-	-	-
N1-SP	N2-SP	Air Pilot	Spring	Single Pressure Piloted	40 PSI	-	-	-
N1-DB	N2-DB	Bleed Pilot	Bleed Pilot	Double Bleed Piloted	40 PSI	-	-	-
N1-HL	N2-HL	Hand Lever	Spring	Light 3lb. Touch	-	-	-	-
N1-PB	N2-PB	Push Button	Push Button	Detent	40 PSI	-	-	-
N1-F4	N2-F4	Foot Pedal	Spring	Foot Valve w/ Cover	-	-	-	-
N1-SCD*	N2-SCD*	Solenoid	Spring	DIN Connector Solenoid	40 PSI	12-24	24-120-220-240	DIN*
N1-SX*	N2-SX	Solenoid	Spring	Explosion Proof	40 PSI	-	120	Conduit
N1-DCD*	N2-DCD*	Solenoid	Solenoid	DIN Connector Solenoids	10 PSI	12-24	24-120-220-240	DIN*
N1-DX	N2-DX	Solenoid	Solenoid	Explosion Proof	10 PSI	-	120	Conduit

\* Connector not included on N2-SCD and N2-DCD. See "DIN Solenoid Connectors" on page 22.

# How To Specify

## Product Information

### DIN Solenoid Connectors

A DIN connector (ordered separately) quickly attaches to the solenoid's prongs and is secured by a single screw.

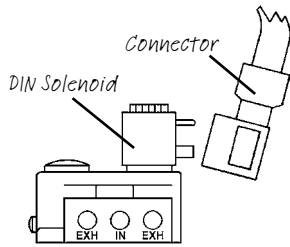

Bimba offers three (3) types of 11mm industrial B-type DIN connectors to facilitate connections to the solenoid. Model PVD1 is a connector with a 1/2" conduit entry and no lead wires. Model PVD2 also has a 1/2" conduit entry but includes 20" of cabled lead wire. Model PVD3 is a strain relief connector that includes 72" of cabled wire. See page 112.



Model PVD1

### Stacking Options

If your application calls for the use of several valves, it is often advantageous to stack them. Because all valves within a stack are supplied air from a common source and are vented through common exhaust ports, plumbing time and fitting costs are greatly reduced.

Stacking also assures that your control valves are located centrally for more convenient troubleshooting and maintenance. Each stack valve body is attached only to its immediate neighbors so that valve additions, replacements, or deletions are easily achieved.

### Flow Patterns

Single-actuated spring return models, including hand lever and foot pedal, have the inlet and Cyl. B ports connected when unactuated. On all double actuated models, except-PB and -DB, signals at P1 cause output at Cyl. A and signals at P2 cause output at Cyl. B. On -PB and -DB models, the reverse occurs.

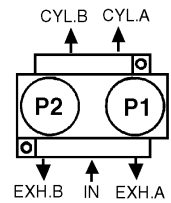

## Dimensions

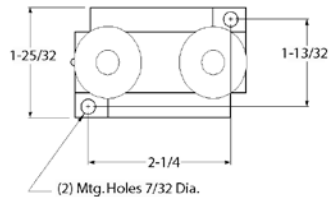

Basic Top View

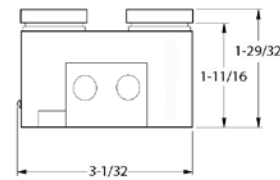

Models N1 & N2  
SCD, DP, SP, DB, and PB

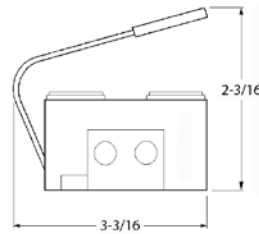

N1-HL & N2-HL

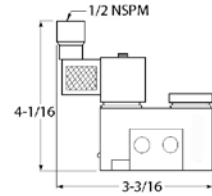

N1-SCD & N2-SCD  
(with connector)

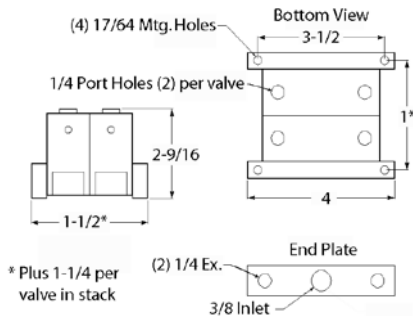

Stacks

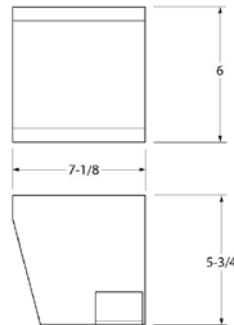

N2-F4

\* Plus 1-1/4 per valve in stack

## How To Order

### Ordering Instructions

**Single Valves:** State model number and voltage, if applicable

**Stacked Valves:** Add an “M” to the single valve model number and state voltage if applicable - specify number and type of valves in each stack. NOTE: Explosion-proof coils may not be stacked next to each other because of their greater size.

**External Pilot Supply:** Add an “E” to the model number.

Operating Parameters N1		Operating Parameters N2	
Media:	Air or Inert Gas	Media:	Air or Inert Gas
Pressure:	Vacuum to 120 PSI	Pressure:	Vacuum to 120 PSI
Port Size:	1/8" NPTF	Port Size:	1/4" NPTF
Pilot Ports:	1/8" NPSF	Pilot Ports:	1/8" NPSF
Flow:	$C_v = 0.7$ (single valves) $C_v = 0.9$ (stacked valves)	Flow:	$C_v = 1.0$ (single valves) $C_v = 1.2$ (stacked valves)
Temperature:	0° F to 120° F (-18° C to 49° C)	Temperature:	0° F to 120° F (-18° C to 49° C)
Lubrication:	Petroleum Base Oil	Lubrication:	Petroleum Base Oil
Filtration:	40 Micron Minimum	Filtration:	40 Micron Minimum
Sol Response:	30-40 ms	Sol Response:	30-40 ms
Seals:	Buna-N	Seals:	Buna-N

N1 = 1/8" ports

## N1-SCD-M-24VAC

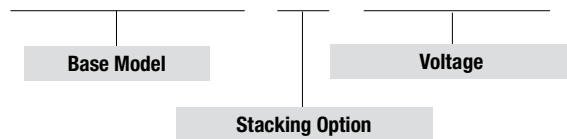

N2 = 1/4" ports

## N2-SCD-M-24VAC

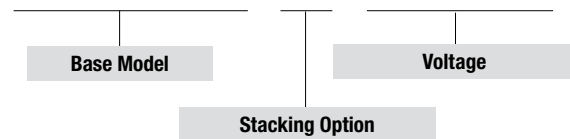

### Valve Symbols

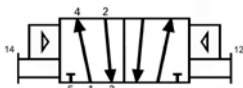

N1-DP & N2-DP

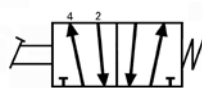

N2-F4

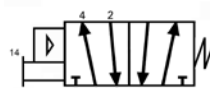

N1-SP & N2-SP

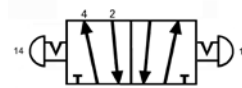

N1-PB & N2-PB

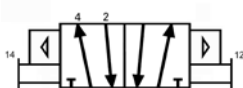

N1-DB & N2-DB

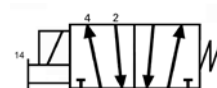

N1-SCD & N2-SCD  
N1-SX & N2-SX



N1-HL & N2-HL

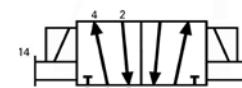

N1-DCD & N2-DCD  
N1-DX & N2-DX

# Product Features

## Features & Benefits

### Sub-Base Mounted

Bimba's Capsula valves work long and hard even when subjected to dirty air. Their unique patented bi-lobed seals are wear-compensating, self-cleaning, and are completely retained to prevent extrusion.

All models are mounted on a side ported sub-base, 4-way, 5 port. Any valve module may be separated from its base in seconds without disturbing the piping.

### Actuators

The Capsula line offers a wide variety of actuator styles including single and double air piloting, hand lever operators, and single & double solenoid piloting.

## Technical Data

### Engineering Specifications

<b>Flow:</b>	1/4" Models - $C_v = 0.75$ (45 SCFM at 100 PSI) 1/2" Models - $C_v = 3.17$ (190 SCFM at 100 PSI)
<b>Max. Air Pressure:</b>	120 PSI
<b>Pilot Ports:</b>	1/8" NPT
<b>Filtration:</b>	40 Micron (extends valve life)
<b>Lubrication:</b>	Required for 1/2" and all 3-position models
<b>Response:</b>	30-40 ms
<b>Temperature:</b>	-20° F to 212° F (-29° C to 100° C)
<b>1/4" Materials:</b>	Module (ABS Cylolac) - Spool (Delrin AF <sup>®</sup> ) Base (Die cast aluminum) - Dupont Company <sup>®</sup>
<b>1/2" Materials:</b>	Module (Phenolic) - Spool (Aluminum) Base (Rolled aluminum)

Single Air Piloted



C2-3

3 Position, Double Air Piloted



C2-2R

Hand Valve



C2-10H

Solenoid Operator

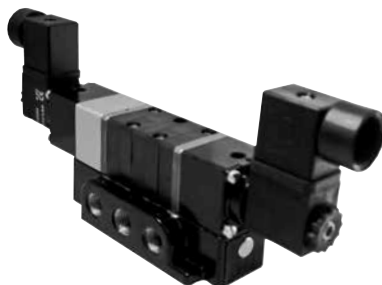

C2-5DCD

Solenoid Operator

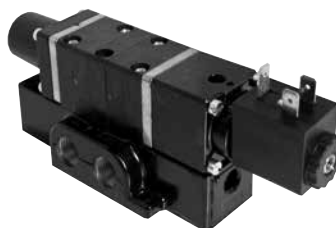

C2-4DCD

Solenoid shown here with two (2) connectors, PVD1 (sold separately)



## Product Information

### DIN Solenoid Connectors

Electrically actuated Capsula valves utilize a 11mm industrial B-type DIN type solenoid. DIN solenoids feature a totally encapsulated coil with 3 prongs, allowing fast and easy connections. DIN connectors are ordered separately. Bimba offers 3 types of DIN connectors to facilitate connections to the solenoid. A full description of these connectors can be found on page 22 & 112.



**Model PVD1**

### Flow Patterns

Capsula valves are 4-way, 5 ported directional control valves. This means that they have one inlet, 2 pressure outputs, and 2 exhaust ports. Dual exhausts facilitate individual flow control of each output port and allow dual pressure and diverter hookups.

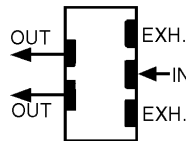

### Two Position Models

Whenever the inlet is charged, flow will occur at one output port or the other.

On double solenoid or double air piloted models, the second actuator replaces the spring.

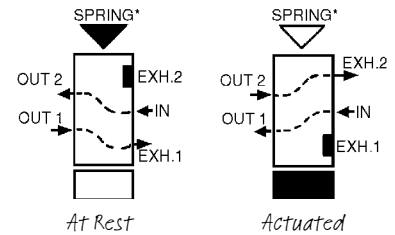

### Three Position Models

Whenever the inlet is charged and neither actuator is signaled, both output ports will either be blocked (pressure held) or exhausted (pressure released). Pressure held models allow a cylinder to be "inched" along. Pressure released models allow the cylinder piston to float in neutral.

### Pressure Held Type (H Models)

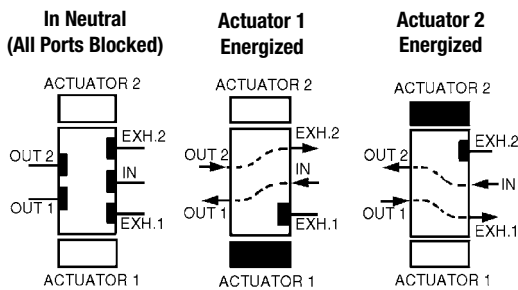

### Pressure Release Type (R Models)

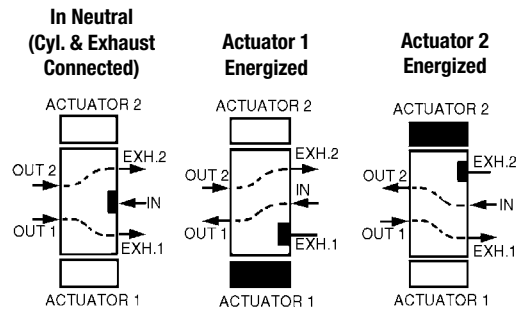

### Dimensions (mm)

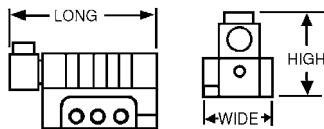

2 mounting holes per valve:  
 1/4" valves - 7/32" diameter  
 1/4" valves - 9/32" diameter

Model	Long	Wide	High
C2-1	4-7/32	2	2-1/4
C5-1	7-7/16	3	3-1/4
C2-2H	7-1/32	2	2-1/4
C2-2R	7-1/32	2	2-1/4
C2-3	4-21/32	2	2-1/4
C5-3	7-31/32	3	3-1/4
C2-4DCD	6-1/2	2	2-1/4
C5-4DCD	10-9/32	3	3-1/8
C2-5DCD	7-3/4	2	3-9/16
C5-5DCD	10-13/16	3	3-1/8
C2-6HDCD	10-25/32	2	3-9/16
C2-6RDCD	10-25/32	2	3-9/16
C2-7	5-3/8	2	5-5/8
C5-7	9-1/32	3	8-9/16
C2-8	5-7/8	2	5-5/8
C5-8	8-21/32	3	8-9/16
C2-9H	6-1/4	2	5-5/8
C2-9R	6-1/4	2	5-5/8
C2-10H	6-1/4	2	5-5/8
C2-10R	6-1/4	2	5-5/8

# How To Order

## How To Order

### Ordering Instructions

State model number and voltage.

# C2-4DCD-120AC



Model Number	Port Size	Actuator	Return	Description	Min. Pilot Pressure (PSI)	Available Voltages	
						DC	AC
C2-1	1/4	Air Pilot	Air Pilot	2-Position, Double Pressure Piloted	20	-	-
C5-1	1/2	Air Pilot	Air Pilot	2-Position, Double Pressure Piloted	20	-	-
C2-2H	1/4	Air Pilot	Spr. Center	3-Position, Double Pressure, Pressure Held in Center	45	-	-
C2-2R	1/4	Air Pilot	Spr. Center	3-Position, Double Pressure, Pressure Released	45	-	-
C2-3	1/4	Air Pilot	Spring	2-Position, Single Pressure Piloted	35	-	-
C5-3	1/2	Air Pilot	Spring	2-Position, Single Pressure Piloted	35	-	-
C2-4DCD*	1/4	Solenoid**	Spring	2-Position, Single DIN Solenoid	35	12-24	24-120-220-240
C5-4DCD*	1/2	Solenoid**	Spring	2-Position, Single DIN Solenoid	35	12-24	24-120-220-240
C2-5DCD*	1/4	Solenoid**	Solenoid	2-Position, Double DIN Solenoid	20	12-24	24-120-220-240
C5-5DCD*	1/2	Solenoid**	Solenoid	2-Position, Double DIN Solenoid	20	12-24	24-120-220-240
C2-6HDCD*	1/4	Solenoid**	Spr. Center	3-Position, Double DIN Solenoid, Pressure Held in Center	45	12-24	24-120-220-240
C2-6RDCD*	1/4	Solenoid**	Spr. Center	3-Position, Double DIN Solenoid, Pressure Released	45	12-24	24-120-220-240
C2-7	1/4	Hand Lever	Spring	2-Position Lever, Spring Return	-	-	-
C5-7	1/2	Hand Lever	Spring	2-Position Lever, Spring Return	-	-	-
C2-8	1/4	Hand Lever	Hand Lever	2-Position Lever, Friction Held	-	-	-
C5-8	1/2	Hand Lever	Hand Lever	2-Position Lever, Friction Held	-	-	-
C2-9H	1/4	Hand Lever	Spr. Center	3-Position Lever, Pressure Held in Center	-	-	-
C2-9R	1/4	Hand Lever	Spr. Center	3-Position Lever, Pressure Released in Center	-	-	-
C2-10H	1/4	Hand Lever	Detented	3-Position Lever, Pressure Held in Center	-	-	-
C2-10R	1/4	Hand Lever	Detented	3-Position Lever, Pressure Released in Center	-	-	-

\* Explosion-proof models available.

\*\* Connector not included on solenoid models; see page 25.

### Valve Symbols



C2-1 & C5-1

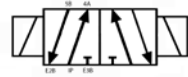

C2-5DCD & C5-5DCD

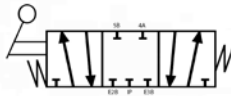

C2-9H

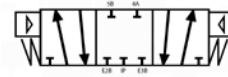

C2-2H

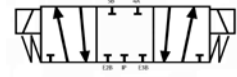

C2-6HDCD

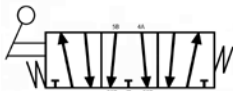

C2-9R

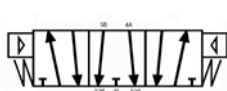

C2-2R

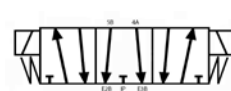

C2-6RDCD

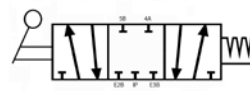

C2-10H

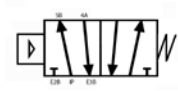

C2-3 & C5-3

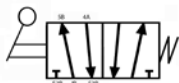

C2-7 & C5-7

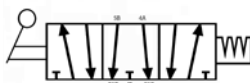

C2-10R

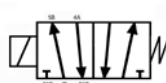

C2-4DCD & C5-4DCD

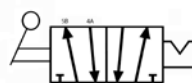

C2-8 & C5-8

## Features & Benefits

### Built-In Speed Controls

Dura-matic 4-way valves not only control cylinder direction but also control cylinder rod speed. Most models include easy-to-use built-in flow controls that permit the user to establish cylinder speeds right at the directional valve.

### Remote Air Piloting

Air piloting is a simple and economical way to operate cylinders or other air driven devices; it eliminates the need for electric wiring or solenoids. Dura-matic models are available as either pressure or bleed remote piloting depending upon the model selected. Single piloted models require one remote pilot valve and double piloted models require two.

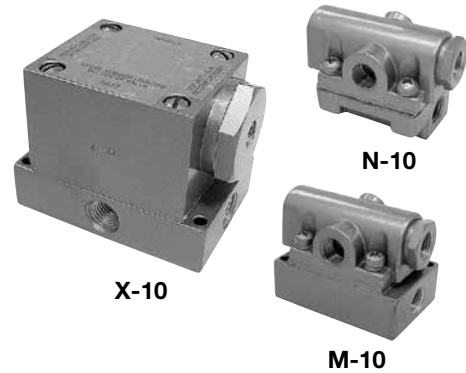

## Technical Data

### Specifications

Pressure:	20 to 150 PSI (min. 30 PSI on W-10)
Temperature:	-40° F to 150° F (-40° C to 66° C)
Lubrication:	Petroleum Base Oil
Filtration:	40 Micron

### Construction

Type:	Slide (wear compensating nylon)
Dynamic Seals:	Buna-N Block Vs
Plate:	Hardened and lapped aircraft quality steel
Exhaust Ports:	Common to both cylinder ports
Speed Controls:	Needle type with check valve to allow free out flow and controlled exhaust flow

# How To Specify

## Product Information

### Pressure Piloted Valves

These valves shift when pressurized air travels from a remote pilot valve to the pilot port of the Dura-matic valve. The table shows the minimum allowable pilot pressures.

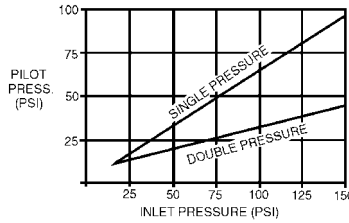

### Bleed Piloted Valves

Bleed piloted models output air from the pilot port(s). When the remote pilot valve is actuated the air is exhausted, causing the valve to shift. In contrast to pressure piloting, bleed pilot valves do not need separate air supplies. However, they do continue to bleed air as long as they are actuated. To the right are two remote bleed pilot valves:

Model	Description	Length	Width
404A	Bleed Limit Valve; 1/8" NPT Fitting	2-1/4"	1/2" Hex
405A	Bleed Limit Valve; 1/4" OD Tubing	2-1/4"	1/2" Hex

A wide variety of pilot operators are provided in the Micro-Line valves section, pages 31-34. This line of valves can be used to remotely pilot either the pressure or the bleed type.

## Dimensions

### L-10, N-10, T-10 and V-10 (all ports 1/8" NPT)

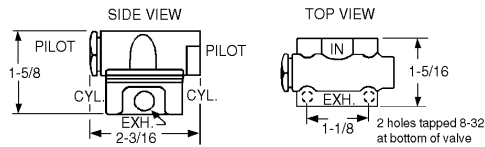

### K-10, M-10, O-10 and U-10 (all ports 1/8" NPT)

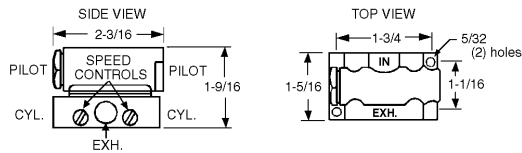

### W-10, X-10, Y-10 and Z-10 (all ports 1/4" NPT)

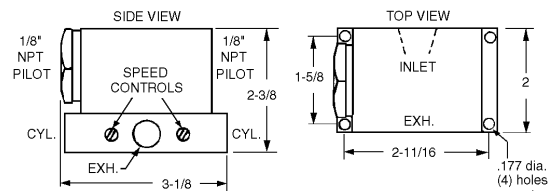

## How To Order

Size (")	Model	Function	Flow*	C <sub>v</sub>
1/8	K-10	Single Pressure	13.6	.24
1/8	M-10	Double Pressure	13.6	.24
1/8	O-10	Single Bleed	13.6	.24
1/8	U-10	Double Bleed	13.6	.24
1/4	W-10	Single Pressure	48.5	.63
1/4	X-10	Double Pressure	48.5	.63
1/4	Y-10	Single Bleed	48.5	.63
1/4	Z-10	Double Bleed	48.5	.63
1/8	L-10 <sup>‡</sup>	Single Pressure	10.1	.11
1/8	N-10 <sup>‡</sup>	Double Pressure	10.1	.11
1/8	T-10 <sup>‡</sup>	Single Bleed	10.1	.11
1/8	V-10 <sup>‡</sup>	Double Bleed	10.1	.11

\* Flow at 100 PSI Inlet pressure (in SCFM)

‡ These models do not have built-in flow controls.

## Valve Symbols

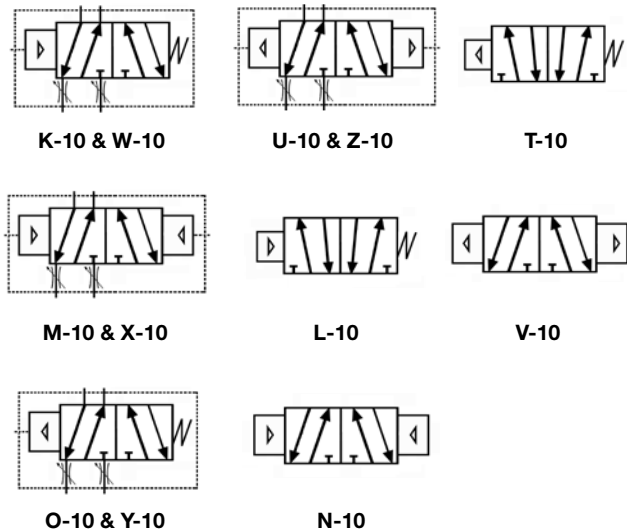

## Features & Benefits

### Reduce the Effects of Repetitive Motion

Many machine operators are required to operate air powered equipment hundreds or thousands of times per day. These types of routines can result in repetitive motion disorders such as Carpal Tunnel Syndrome. The debilitating effects usually result in increasing worker compensation claims and declining employee productivity.

Ergonomically designed to respond to extremely low actuation forces, Bimba's Low Stress actuators require as little as 6 ounces of force to initiate a signal. This valve will dramatically reduce the demands on your workers' hands, wrists and arms.



## Technical Data

### Operating Specifications

LTV Low Stress valves are ported 1/8" NPT. They are shipped with a 3-way normally closed flow pattern for pilot applications, but can be easily converted to 3-way normally open or 4-way flow by removing a port plug.

Specifications	
Temperature:	0° F to 115° F (-18° C to 46° C)
Pressure:	25-125 PSI air
Filtration:	Standard 40 Micron filter recommended to prolong seal life
Lubrication:	Petroleum Based Oil
Flow at 100 PSI:	14 SCFM
Flow:	0.24 C <sub>v</sub>

# How To Specify

## Product Information

### Mounting Options

The Low Stress Series allows you to choose between three distinct mounting options. Mounting holes are located in the valve body for standard side mounting. For foot bracket or panel mounting, be sure to specify the proper model number (listed below).

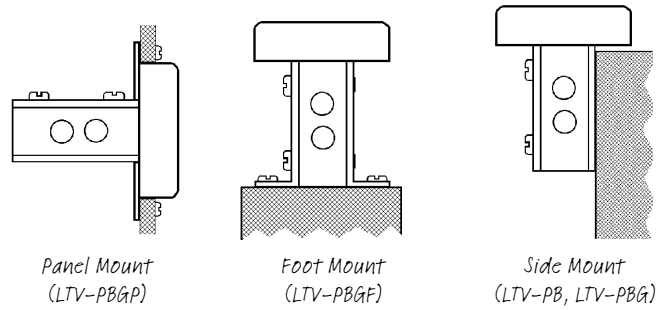

### Low Stress Two-Hand Control

To provide safer operation of assembly equipment and other machinery, use the LTV Low Stress valves with the CSV-107 two-hand control unit. When used as directed, this unit demands concurrent actuation from two remote inputs before a signal can be initiated. Further, the release of one or both inputs immediately stops the output signal. The unit cannot recycle until both valves are again simultaneously actuated. The CSV-107 requires no electrical connections. For more information regarding the CSV-107, please see page 95.

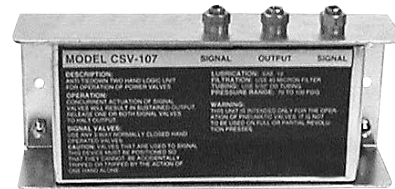

### Dimensions

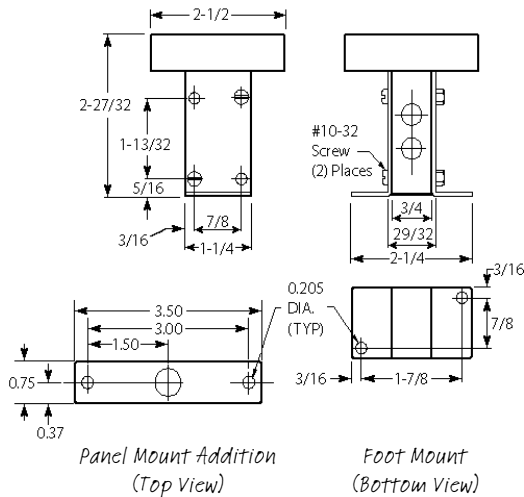

### How To Order

Three actuator stickers (red, green and black) are included with each valve. All models may be configured 3-way normally open, 3-way normally closed or 4-way.

Model #	Description
LTV-PB	Basic Valve (Unguarded); For Side Mounting
LTV-PBG	Valve with Button Guard; For Side Mounting
LTV-PBGF	Valve with Button Guard; For Foot Mounting
LTV-PBGP	Valve with Button Guard; For Panel Mounting

### Valve Symbol

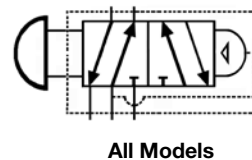

## Features & Benefits

### Light-Touch, Snap-Acting Control Valves

Bimba's LTV valves are compact 1/8" ported 4-way valves that may be actuated by hand, remote air signal, electric signal, or mechanically by a machine element. They are ideal for powering small or medium sized cylinders and for piloting larger valves. Some models require as little as 4 ounces of force and .010" of plunger travel to actuate. See the chart on the opposite page for individual valve specifications.

## Technical Data

Specifications	
Pressure Range:	25 to 125 PSI (Solenoid models to 100 PSI)
Temperature:	0° F to 115° F (-18° C to 46° C)
Flow:	0.24 C <sub>v</sub>
Flow at 100 PSI:	14 SCFM
Ports:	1/8" NPT Standard; LTV-60 and LTV-110 pilot ports are 10-32
Lubrication:	Petroleum Base Oil
Filtration:	40 Micron Minimum
Body:	Cast Aluminum
Seals:	Buna-N
Spool:	Aluminum
Response:	20-30 ms

# Product Features

## Product Information

\* For 15/32" panel openings; 15/32-32 UNS

\*\* For 1 3/16" panel openings



**LTV-5**  
Pin Plunger



**LTV-10**  
Straight  
Leaf



**LTV-15**  
Roller Leaf  
**LTV-90**  
Nylon Roller



**LTV-20**  
One-Way  
Roller Leaf



**LTV-25\***  
Roller Plunger



**LTV-30\***  
Cross Plunger



**LTV-35\***  
Flip Toggle



**LTV-40\***  
Ball Roller



**LTV-45\***  
Straight Plunger



**LTV-50**  
Fingertip Lever



**LTV-60**  
Single Pressure  
**LTV-110**  
Double Pressure



**LTV-60L**  
Low Pressure



**LTV-75**  
Roller



**LTV-80**  
One-Way Roller



**LTV-85**  
Extended Rod (6'')



**LTV-115DD**  
Single Solenoid



**LTV-120DD**  
Double Solenoid



**LTV-125, LTV-130**  
Knob\* (LTV-125 has  
threaded stem)



**LTV-140\***  
Palm



**LTV-MH\*\***  
Mushroom Head



**LTV-TP\*\***  
Two Position  
Detent



**LTV-EH\*\***  
Extended Head  
**LTV-FH\*\***  
Flush Head



## Product Information

### Micrometer Trip Position

An optional screw adjustment on the valve lever allows the user precision control of the valve actuator. Specify LTV-10A, LTV-15A, or LTV-20A.

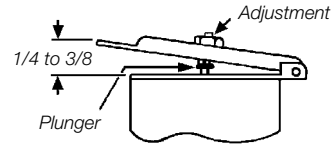

### DIN Solenoid Connectors

Electrically actuated LTV valves utilize DIN type solenoids. DIN solenoids feature a totally encapsulated coil with 3 prongs, allowing fast and easy connections. DIN connectors are ordered separately. Bimba offers 3 types of DIN connectors to facilitate connections to the solenoid. A full description of these connectors can be found on page 112.



Solenoid shown with connector PVD1 (sold separately)

### LTV Valve Stacks

Stacked valves reduce piping requirements by eliminating the need for a separate air supply to each valve. All LTV valves are stackable except LTV-75, 80, 85, 140, MH, TP, EH, FH and ES. When LTV-50, LTV-115DD or LTV-120DD valves are stacked, 1/4" spacers are added between valves. To order, add "M" to the model number, specify number, type and position of valves.



Solenoids shown here with connector PVD1 (sold separately)

### LTV Flow Patterns

For all models except LTV-60, which is opposite.

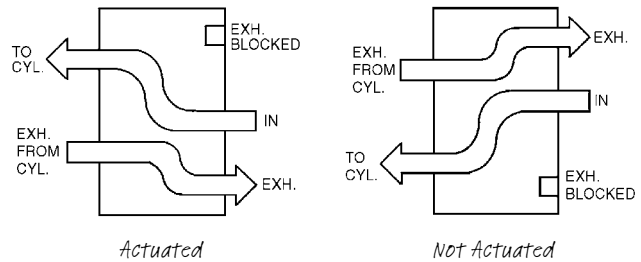

## Dimensions

NOTE: Envelope dimensions of valves with actuators are shown in the chart on page 34.

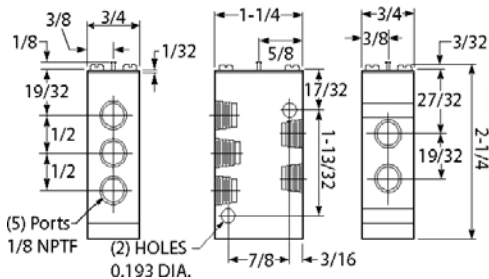

# How To Order

## How To Order

Model	Actuator	Return	Act. Force @ 80 PSI	Appx. Act. Stroke Distance		Length (")	Width (")	Height (")
				Full Open	Over Travel			
LTV-5	Pin Plunger	Air Spring	13 oz.	.016	.094	1-1/4	3/4	2-3/8
LTV-10	Straight Leaf	Air Spring	5.5 oz.	.016	.156	2-3/32	3/4	2-1/2
LTV-10A	Adjustable Leaf	Air Spring	5.5 oz.	.016	.156	2-3/32	3/4	2-5/8
LTV-15	Roller Leaf	Air Spring	5.5 oz.	.016	.156	2-5/32	3/4	2-7/8
LTV-15A	Adjustable Roller Leaf	Air Spring	5.5 oz.	.016	.156	2-5/32	3/4	3
LTV-20	1-Way Roller Leaf	Air Spring	5.5 oz.	.016	.156	2-3/32	3/4	3-11/32
LTV-20A	Adjustable Roller Leaf	Air Spring	5.5 oz.	.016	.156	2-3/32	3/4	3-15/32
LTV-25	Roller Plunger	Air Spring	13 oz.	.016	.058	1-1/4	3/4	3-5/8
LTV-30	Cross Plunger	Air Spring	13 oz.	.016	.058	1-1/4	3/4	3-5/8
LTV-35	Flip Toggle	Detent	9.25 oz.	30°	-	1-1/4	3/4	3-25/32
LTV-40	Ball Roller	Air Spring	13 oz.	.016	.094	1-1/4	3/4	3-1/32
LTV-45	Straight Plunger	Air Spring	13 oz.	.016	.094	1-1/4	3/4	3-11/32
LTV-50	Fingertip Lever	Air Spring	5.5 oz.	.016	.156	2-17/32	3/4	2-11/16
LTV-60+	Single Pressure~	Air Spring	-	-	-	1-1/4	3/4	2-11/32
LTV-60L*	Low Pressure	Air Spring	-	-	-	1-1/4	3/4	3-3/32
LTV-75	Heavy-Duty Roller	Air Spring	14 oz.	.031	.313	2-7/32	3/4	4-5/32
LTV-80	Heavy-Duty 1-Way Roller	Air Spring	14 oz.	.031	.313	2-13/32	3/4	3-17/32
LTV-85	Heavy-Duty Extended Rod	Air Spring	4 oz.	.125	.500	6- 1/4	3/4	3-17/32
LTV-90	Nylon Roller	Air Spring	5.5 oz.	.016	.156	2-5/32	3/4	3
LTV-110	Double Pressure~	Ext. Air Pilot	-	-	-	1-1/4	3/4	2-11/32
LTV-115DD**	Solenoid (DIN)	Air Spring	-	-	-	1-5/8	7/8	3-9/32
LTV-120DD**	Solenoid (DIN)	Solenoid	-	-	-	1-5/8	7/8	4-19/32
LTV-125	Knob	Air Spring	13 oz.	.016	-	1-1/4	5/8	3-19/32
LTV-130	Knob	Detent	2 lbs.	.094	.125	1-1/4	5/8	3-9/32
LTV-140	Palm	Air Spring	13 oz.	.016	.094	1-3/8	1 3/8	3-25/32
LTV-MH^	Mushroom Head	Air Spring	1 lb.	.218	.047	1-5/8	1 5/8	4-5/8
LTV-TP	Two Position	Detent	-	-	-	1-5/8	1 5/8	4-5/16
LTV-EH^	Extended Head	Air Spring	-	-	-	1-5/8	1 5/8	3-3/4
LTV-FH^	Flush Head	Air Spring	-	-	-	1-5/8	1 5/8	3-7/16

\* Minimum pilot pressure of 25 PSI required.

\*\* Specify voltage: 12DC, 24DC, 24AC, or 120AC

^ Specify actuator color: red, green or black

+ Pilot pressure must equal at least 60% of inlet pressure.

~ 10-32 pilot port

## Valve Symbols

### Solenoid Models:

24 VDC = 6.5 watts / .27 amp

120 VAC = 8.5 watts / .07 amps

**Only Model Numbers are indicated**

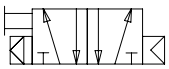

LTV-5, 10, 45, 50 & 85

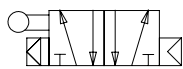

LTV-15, 25, 30, 40, 75 & 90

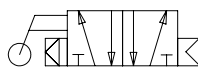

LTV-20 & 80

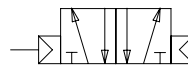

LTV-60 & 60L

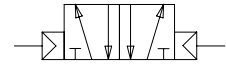

LTV-110

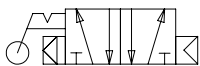

LTV-35 & TP

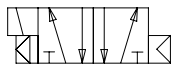

LTV-115DD

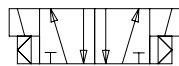

LTV-120DD

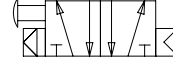

LTV-125, 140, MH, EH & FH

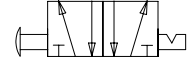

LTV-130

## Features & Benefits

---

Bimba's MV air switches are 3-way 1/8" ported air pilot valves that are identical in size, actuating style, and mounting characteristics to most industrial type electric limit switches. Use them in place of electric limits to save on hookup cost and eliminate spark hazard. MV valves simplify circuits by eliminating the need for wire shielding, transformers, and solenoids.

## Technical Data

---

Specifications	
Pressure Range:	Vacuum to 120 PSI
Media:	Air or Inert Gas
Flow:	0.11 C <sub>v</sub>
Flow at 100 PSI:	6 SCFM
Ports:	1/8" NPT
Force to Actuate:	As Low as 6.4 Ounces
Max. Ambient Temperature:	115° F (46° C)
Lubrication:	Not Required
Filtration:	40 Micron
Seals:	Viton
Spool:	Dupont Teflon®
Body:	Cast Zinc

# Product Features

## Product Information

\* For 15/32" panel openings; 15/32-32 UNS  
 ‡ For 30mm (1-3/16") nominal panel opening

MV SERIES 3-WAY SWITCHES

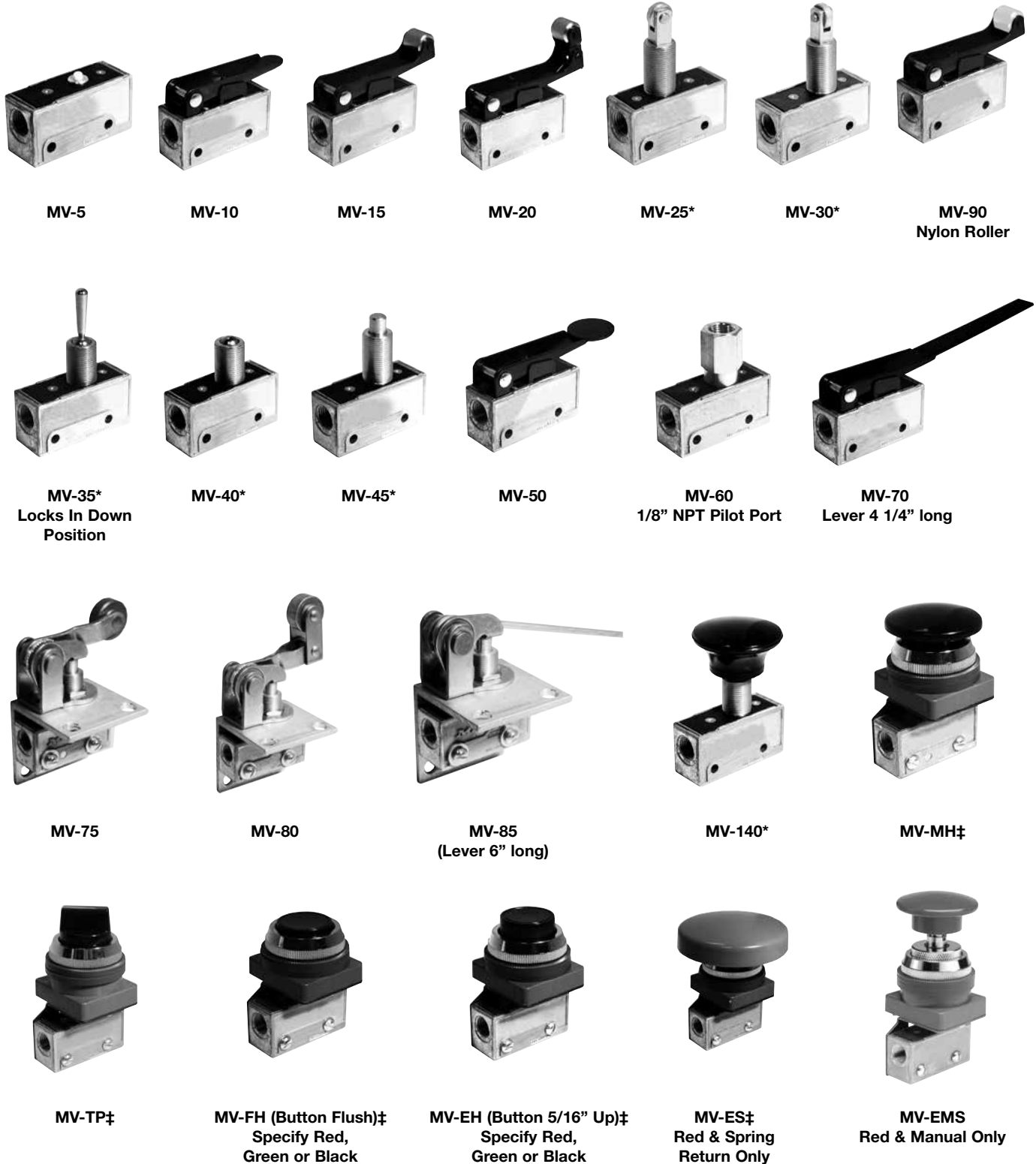

**MV-5**

**MV-10**

**MV-15**

**MV-20**

**MV-25\***

**MV-30\***

**MV-90**  
Nylon Roller

**MV-35\***  
Locks In Down Position

**MV-40\***

**MV-45\***

**MV-50**

**MV-60**  
1/8" NPT Pilot Port

**MV-70**  
Lever 4 1/4" long

**MV-75**

**MV-80**

**MV-85**  
(Lever 6" long)

**MV-140\***

**MV-MH‡**

**MV-TP‡**

**MV-FH (Button Flush)‡**  
Specify Red, Green or Black

**MV-EH (Button 5/16" Up)‡**  
Specify Red, Green or Black

**MV-ES‡**  
Red & Spring Return Only

**MV-EMS**  
Red & Manual Only

## Product Information

The MV air switch may be piped normally closed, normally open, or as a diverter. These alternatives are described in detail below.

### NORMALLY CLOSED

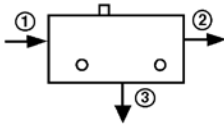

Pressurized air flows from 1 to 2 when button is pushed.  
Exhaust air flows from 2 to 3 when button is released.

### NORMALLY OPEN

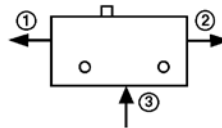

Pressurized air flows from 3 to 2 when button is not pushed.  
Exhaust air flows from 2 to 1 when button is pressed.

### DIVERTER

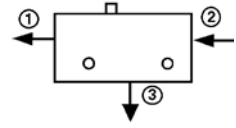

Pressurized air flows from 2 to 1 when button is pushed.  
Pressurized air flows from 2 to 3 when button is released. This hookup does not provide for exhaust.

### Perform "AND" Logic Function with MV-60

This hookup provides that flow will occur at C only when air signals are received at A and B. The MV-60 is a 3-way air piloted valve.

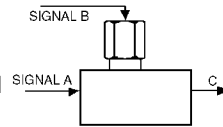

### Add Push to Connect 1/4" Fittings

MV valves are available with 1/4" brass push to connect fittings. The valve will be provided with a fitting for the inlet, outlet and the exhausts ports. Any MV valve may utilize this option. The valve's body height increases by 5/16" and the mounting holes are 0.532" apart.



MV-25-C4

## Dimensions

NOTE: Envelope dimensions of valves with actuators are shown in the chart on page 38.

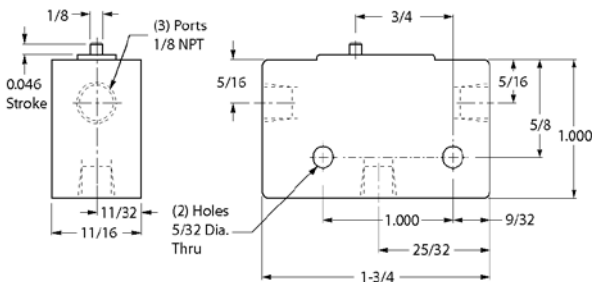

### Model #2060400G (Guarded)

NOTE: 2060400 and 2060400G are provided with push to connect fittings as the C4 option (described above).

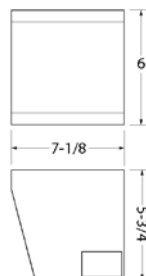

### Model #2060400

Model has plug-in fittings for 1/4" OD tube

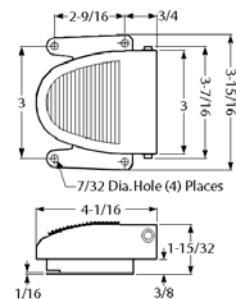

# How To Order

## How To Order

Model	Actuator	Act. Force lbs. @ 100 PSI		Approximate Actuator Stroke Distance			Envelope Dimensions		
		NC	NO	To Crack Open	To Full Open	Over Travel	Len.	Wid.	Hgt.
MV-5	Pin Plunger	2.5	3.3	.035	.046	.035	1-3/4	11/16	1
MV-10	Straight Leaf	1.2	1.5	.100	.137	.079	2-3/16	11/16	1-1/4
MV-15	Steel Roller	1.0	1.3	.100	.137	.079	2-3/16	11/16	1-5/8
MV-20	1-Way Roller Leaf	1.0	1.3	.100	.137	.079	2-3/16	11/16	2-1/16
MV-25	Roller Plunger	2.8	3.5	.035	.046	.120	1-3/4	11/16	2-3/16
MV-30	Cross Roller	2.8	3.5	.035	.046	.120	1-3/4	11/16	2-5/16
MV-35	Flip Toggle	1.5	2.3	35°	35°	35°	1-3/4	11/16	2-5/16
MV-40	Ball Roller	2.5	3.3	.035	.046	.035	1-3/4	11/16	1-19/32
MV-45	Straight Plunger	2.5	3.3	.035	.046	.155	1-3/4	11/16	1-29/32
MV-50	Fingertip Lever	1.0	1.3	.100	.137	.079	2-5/8	11/16	1-3/8
MV-60	Pressure Piloted	40*	40*	-	-	-	1-3/4	11/16	1-5/8
MV-70	Extended Leaf	0.7	1.0	.255	.315	.195	4-1/2	11/16	1-9/16
MV-75	HD Roller Leaf	2.8	3.5	.093	.119	.129	2-1/4	1-3/4	3-7/16
MV-80	HD 1-Way Roller	2.8	3.5	.093	.119	.129	2-1/8	1-3/4	4-1/8
MV-85	HD Extended Rod	0.4	0.6	.637	.782	.330	6-1/4	1-3/4	3-1/8
MV-90	Nylon Roller	1.0	1.3	.100	.137	.079	2-3/16	11/16	1-5/8
MV-140	Palm Actuator	2.5	3.3	-	-	-	1-3/4	1-3/8	2-1/4
MV-MH	Mushroom Head	-	-	-	-	-	1-13/16	1-5/8	3-5/16
MV-TP	Two Position	-	-	-	-	-	1-13/16	1-5/8	2-31/32
MV-FH	Flush Head	-	-	-	-	-	1-13/16	1-5/8	2-1/8
MV-EH	Extended Head	-	-	-	-	-	1-13/16	1-5/8	2-7/16
MV-ES	Emergency Stop	-	-	-	-	-	2-3/8	2-3/8	3-5/16
MV-EMS	Emergency Stop	-	-	-	-	-	1-3/4	1-5/8	3-1/4

\* PSI  
 NO = Normally Open  
 NC = Normally Closed

### Valve Symbols

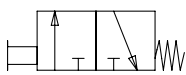

MV-5, 10, 45, 50, 70 & 85

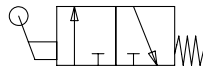

MV-20 & 80

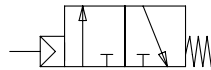

MV-60

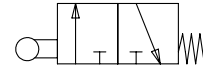

MV-15, 25, 30, 40, 75 & 90

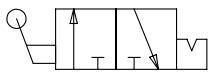

MV-35, TP & EMS

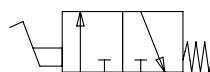

2060400

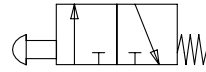

MV-140, EH, FH, MH & ES

## Features & Benefits

These compact air valves provide economical cam, fingertip, palm, hand, and foot actuation. 3-way models are ideal for actuating single-acting cylinders and 4-way directional valves. 4-way models are suitable for the control of double-acting cylinders. Three types of spool designs are available.

## Technical Data

Specifications	
<b>Media:</b>	Air to 150 PSI
<b>Temperature Range:</b>	-40° F to 250° F (-40° C to 121° C)
<b>Cam Buttons:</b>	Hardened Steel
<b>Spring:</b>	Stainless Steel
<b>Seals:</b>	Buna-N
<b>Body:</b>	Machined Aluminum
<b>Body (4B-1, 4W-1, 201 and 3C-1):</b>	Die Cast Zinc



# How To Specify

## Product Information

### Poppet Spool Type

A high degree of reliability is achieved by these valves with the simple yet efficient poppet type design. A short operating stroke assures instantaneous response while minimizing operator fatigue.

### Balanced Spool Type

Actuating Force remains constant regardless of air pressure due to the balanced spool design. This series is particularly suited for use in situations where a high rate of flow is required through a 3-Way cam or palm button valve. Additionally, the spool design eliminates the momentary loss of pressure due to valve shifting

### Flow Patterns

Model 201 may be adjusted in seconds during installation to be detented or spring return. The valve may be set up as either normally open or normally closed for spring return operation.

NOTE: In neutral, cylinder ports are dumped to atmosphere.

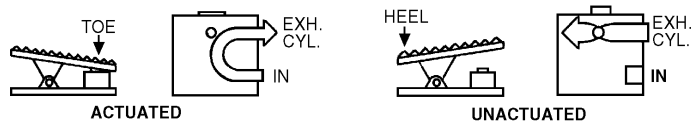

Model 201

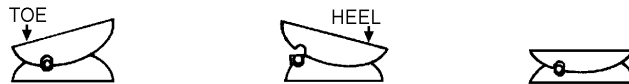

Models 4W-1

### Dimensions

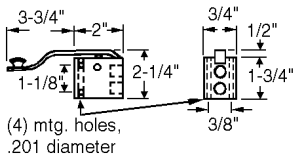

Models FC-1, & FC-2A, FT-1, FT-2A

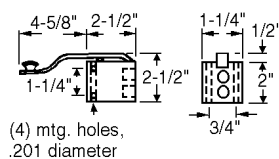

Models FC-101 & FT-101

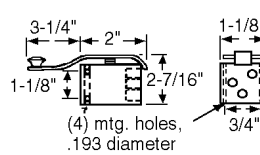

Model FT-4

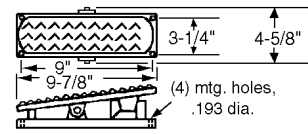

Model 201

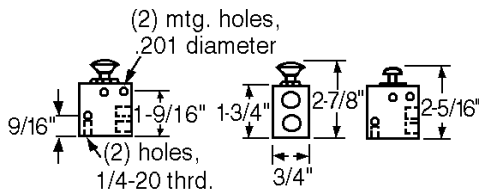

Models FC-51, FC-52, PC-51, PC-51A & PC-52

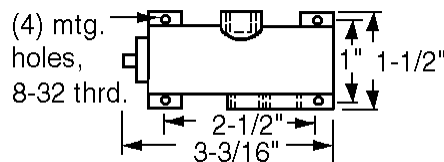

NOTE: height is 1-1/2".

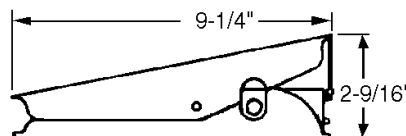

NOTE: width is 3-5/16".

Model 4W-1



## How To Order

Model Number	Actuator	Style	Port (NPT)	Flow (C <sub>v</sub> )	Pre-Travel	Over Travel	Force Req. @ 100 PSI
FC-1	Cam Button	3-Way NC	1/8"	0.13	3/64"	None	17lbs.
FC-2A	Cam Button	3-Way NO	1/8"	0.32	1/8"	1/8"	11lbs.
FC-101	Cam Button	3-Way NC	3/8"	1.15	1/16"	None	30lbs
FT-1	Fingertip Lever	3-Way NC	1/8"	0.13	1/4"	None	4lbs.
FT-2A	Fingertip Lever	3-Way NO	1/8"	0.32	7/8"	1/8"	2lbs.
FT-4	Fingertip Lever	4-Way	1/8"	0.16	7/8"	None	3lbs.
FT-101	Fingertip Lever	3-Way NC	3/8"	1.15	3/16"	None	8lbs.
201	Foot Treadle	3-Way	3/8"	1.15	5/8"	None	7-1/2 lbs.

Model Number	Actuator	Style	Port (NPT)	Flow (C <sub>v</sub> )	Pre-Travel	Over Travel	Force Req. @ 100 PSI
3C-1	Cam Button	3-Way NC	1/4"	0.48	1/16"	None	9lbs.
4W-1	Foot Treadle	4-Way	1/4"	0.48	5/16"	None	18lbs.

Model Number	Actuator	Style	Port (NPT)	Flow (C <sub>v</sub> )	Pre-Travel	Over Travel	Force Req. @ 100 PSI
FC-51	Cam Button	3-Way NC	1/8"	0.81	1/8"	1/8"	7lbs.
FC-52	Cam Button	3-Way NO	1/8"	0.68	1/8"	1/8"	5lbs.
PC-51	Palm Button Spr. Ret.	3-Way NC	1/8"	0.81	1/8"	1/8"	7lbs.
PC-51A	Palm Button Detent	3-Way NC	1/8"	0.81	1/8"	1/8"	3lbs.
PC-52	Palm Button	3-Way NO	1/8"	0.68	1/8"	1/8"	5lbs.

## Valve Symbols

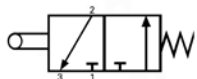

FC-1, FC-2A & FC-101

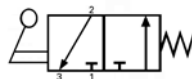

FT-1 & FT-101

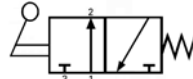

FC-2A



FT-4

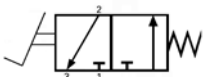

201 (NC Setup)

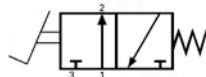

201 (NO Setup)

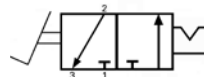

201 (Detent Setup)

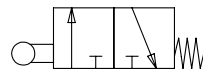

FC-51

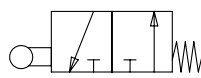

FC-52

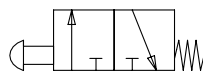

PC-51

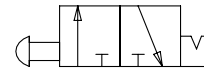

PC-51A

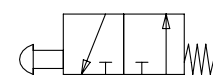

PC-52

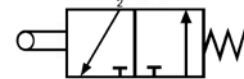

3C-1



4W-1



# Cylinders

Pneumatic cylinders are one of the most prevalent motion options on the market. They can fill a variety of application needs, providing cost-effective and powerful solutions to your motion problems. Bimba offers a diverse array of pneumatic actuators, including the repairable Centaur series, traditional tie rod cylinders, and the Space Saver series, among many others.

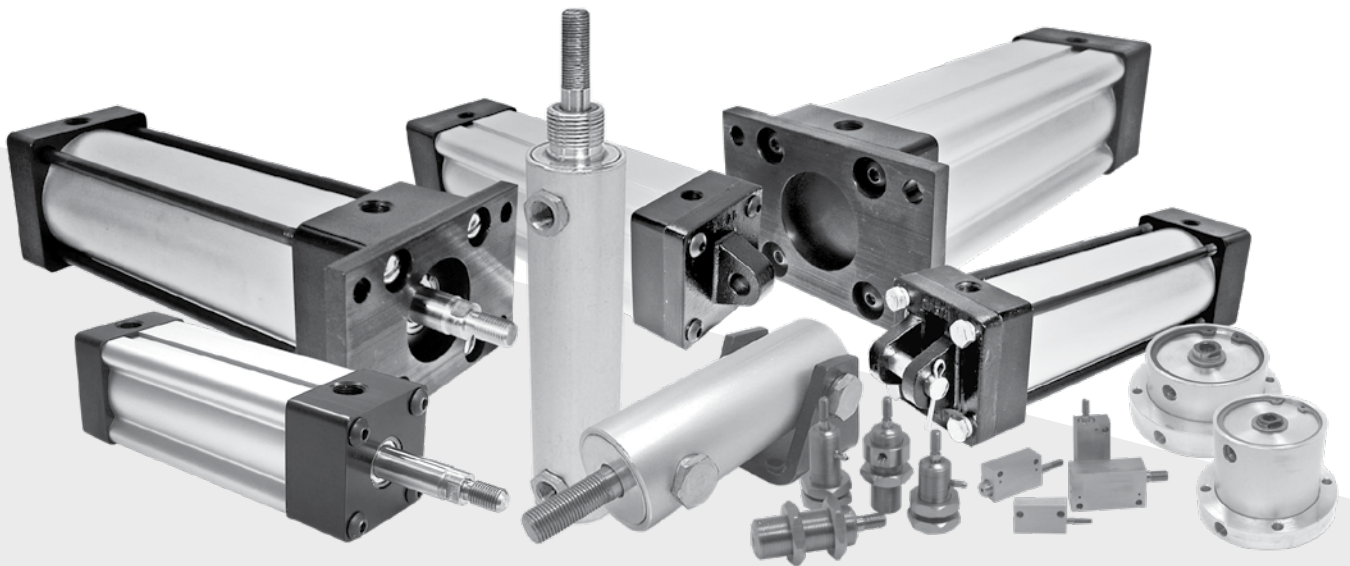

# Contents

- 
- 45 Small Bore Tie Rod Cylinders
    - 45 – Materials & Technical Data
    - 45 – Operating Parameters
    - 46 – Cushion, Sensor Stroke Completion & Rod Coupler Options
    - 47 – Dimension
    - 48 – How To Order
- 
- 49 Dyna-Mation Series Cylinders
    - 49 – Materials & Technical Data
    - 49 – Operating Parameters
    - 50 – Rod Cylinders, Flow Controls & Cushion Options
    - 50 – Mounting & Flanges
    - 51 – Dimensions
    - 53 – Accessories
    - 54 – How To Order
- 
- 56 HD1 Series Cylinders
    - 56 – Materials & Technical Data
    - 56 – Operating Parameters
    - 57 – Dimensions
    - 61 – Accessories
    - 63 – How To Order
- 
- 65 HD Large Bore Tie Rod Cylinders
    - 65 – Materials & Technical Data
    - 65 – Operating Parameters
    - 66 – Dimensions & Mounting Options
    - 67 – How To Order
- 
- 68 Centaur Series Cylinders
    - 68 – Features & Benefits
    - 68 – Technical Data
    - 68 – Operating Parameters
    - 69 – Dimensions
    - 70 – Accessories
    - 70 – How To Order
- 
- 71 Proximity (Reed/Solid State) Switches
    - 71 – Installation & Operation
    - 71 – Connection Diagrams
    - 71 – How To Order
- 
- 72 Space Saver
    - 72 – Features & Benefits
    - 72 – Range of Power & Technical Data
    - 73 – Dimensions, Stroke Availability & Mounting Options
    - 73 – How To Order
- 
- 74 MA & MF Series Miniature Air Cylinders
    - 74 – Features & Benefits
    - 74 – Technical Data
    - 75 – Dimensions
    - 76 – Accessories & Mounting Blocks
    - 76 – How To Order
- 
- 77 Single Acting Air Clamps
    - 77 – Features & Benefits
    - 77 – Technical Data
    - 78 – Dimensions
    - 78 – How To Order
-

## Features & Benefits

### Double-Rod Cylinders

Cylinders having a common piston rod that protrudes from both ends are available in all bore sizes. In addition to providing a dual power source, double rod cylinders serve to minimize rod deflection and to facilitate the control and adjustment of rod travel.

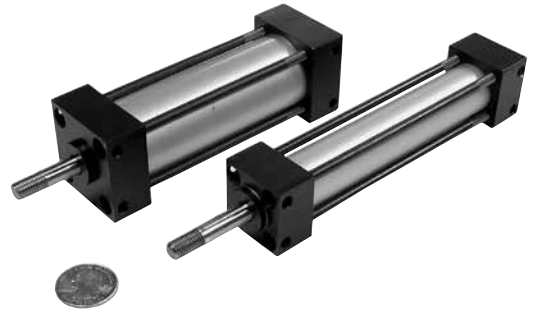

Cylinder Materials	
<b>Cylinder Heads</b>	Machined from solid aluminum; black anodized
<b> Tubes</b>	Aluminum hard anodized to 60 Rc (16 RMS finish)
<b>Piston</b>	Solid high alloy aluminum
<b>Rod</b>	Hard chrome plated ground and polished steel
<b>Bearing</b>	Long wearing, oil impregnated porous bronze
<b>Piston &amp; Rod Seals</b>	Wear compensating Buna-N vee rings
<b>Rod Wiper</b>	PTFE
<b>Tie Rods</b>	High tensile steel torqued to allow for flexure.

## Technical Data

Specifications	
Temp. Range:	-40° F to 250° F (-40° C to 121° C) (to 400° F [204° C] on request)
Lubrication:	Not necessary, but will extend cylinder life when operated with dry air.
Filtration:	Not essential, but a standard 40 micron filter placed upstream will prolong seal life.

## Operating Parameters

Bore Diameter	Thrust*	Thrust Mult.**	Rod Diameter (In.)	Max. Oper. Air Pressure
3/4"	44	.44	5/16	250
1-1/8"	100	1.00	5/16	250

\* Pushing force of cylinder at 100 PSI inlet pressure. Pulling force will be about 10% less due to the displacement of the piston rod. NOTE: Actual realizable thrust could be somewhat lower due to side loading and internal friction. It is best to oversize your cylinder by about 25% to assure smooth operation.

\*\* To determine thrust at other inlet pressures, multiply factor by the desired pressure.

# How To Specify

## Product Information

### Specify Cushions for Shock Absorption

Model DM-112 is available with adjustable cushions that decelerate the piston rod over the last 1 1/16" of stroke. They allow the user to set the degree of cushioning needed for each specific application.

**NOTE:** Cushions are not recommended for hydraulic use.

### Pneumatic End-of-Stroke Sensors (Inter-Pilots®)

A miniature 3-way valve built into the cylinder head is actuated by the cylinder piston as it reaches the end of its stroke. Once contacted, the 3-way Inter-Pilot® valve emits an air signal. In this manner, sequencing is achieved without external limit switches and electric wiring.

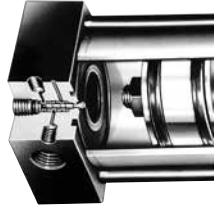

Inter-Pilots® may be built (10-32 Ports) into either or both cylinder heads. They are not for hydraulic use. Cylinder operating pressure must not exceed pressure used to feed the Inter-Pilot®. Inter-Pilots® are not available on DM-075.

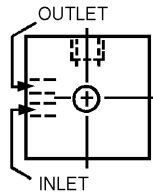

### Pneumatic Stroke Completion

Port mounted SCS valves emit an air signal when the cylinder rod has stopped even if the piston has not contacted the end cap. SCS valves are ideal for use in situations where the full cylinder stroke is not used. See page 53.



### Self Aligning Rod Couplers

Rod couplers simplify cylinder alignment problems by compensating for 2° angular error and 1/16" lateral misalignment on both extension and retraction strokes. Greater reliability is achieved by reducing cylinder and component wear. Order model #DMA-312 for these small bore cylinders. For other models, see page 53 for dimensions.



Part #	Rod Thread	Cylinder Type
DMA-312	5/16-24	C-112, DM-075, DM-112
DMA-375	3/8-24	No Standard
DMA-437	7/16-20	DM-150, DM2-150, HD1-150, DM-200, DM2-200, HD1-200, DM-250, DM2-250, HD1-250
DMA-500	1/2-20	C-150
DMA-625	5/18-18	C-250
DMA-750	3/4-16	DM-325, DM2-325, HD1-325, DM-400, DM2-400, HD1-400
DMA-875	7/8-14	No Standard
DMA-1000	1-14	C-300, DM-600, HD1-600
DMA-1250	1-1/4-12	No Standard

## Product Information

### Dimensions

Bore	3/4	1-1/8
A	1/2	1/2
CB	-	5/8
CD	25/64	25/64
CR	2-1/4	2-1/4
CW	-	1/2
DD	13/64	13/64
E	1-1/4	1-5/8
EB	1-7/16	1-7/16
EE (NPTF)	1/8	1/8
EF	11/32	11/32
EJ	13/64	13/64
F	-	1/8
FB	7/32	7/32
G	3/4	3/4
J	3/4	3/4
KK	5/16-24	5/16-24
FL	1-1/8	5/8 Clevis 1-1/4 Pivot
M	-	3/8
MM	5/16	5/16
NT	13/64-Thru	13/64-Thru
R	13/16	1-1/8
RT	10-32	10-32
ST	9/32	9/32
SV	5/16	5/16
TF	2-13/32	2-25/32
TN	13/16	1-1/8
UF	2-29/32	3-9/32
W	1/2	1/2
XT	11/16	11/16
H	7/8	7/8
HA	1-1/4	1-1/4
HB	1/4	1/4
HC	5/8	5/8
HD	5/16	5/16
HE	3/4	3/4
SN*	1-3/4	1-3/4
XD*	3-3/4	3-7/8 Pivot 3-1/4 Clevis
ZJ*	2-5/8	2-5/8
ZM**	3-1/8	3-1/8

\* Add Stroke Length to Dimension  
 \*\* Add 2x Stroke Length to Dimension

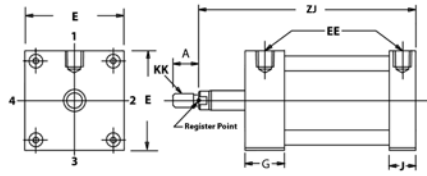

Basic Cylinder

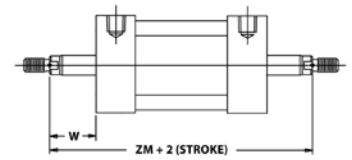

Double Rod Model DR

NOTE: DM1 cylinders are constructed with sleeve nuts. For DM1, use RT; K does not exist. For DM2, use K; RT does not exist.

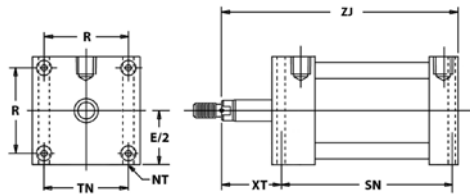

Bottom Flush Model FB

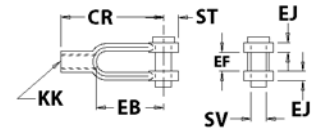

DMC Forged Rod Clevis w/Pin

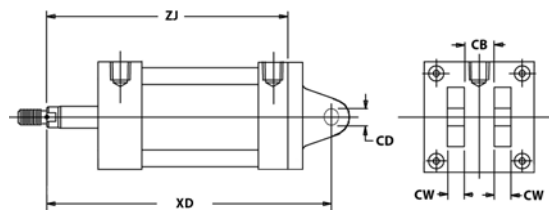

Clevis Model PB

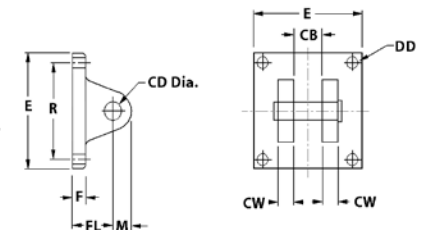

DMR Clevis Bracket w/Pin  
1-1/8" Only

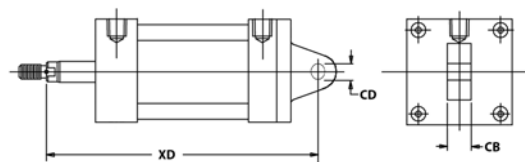

Pivot Model PE

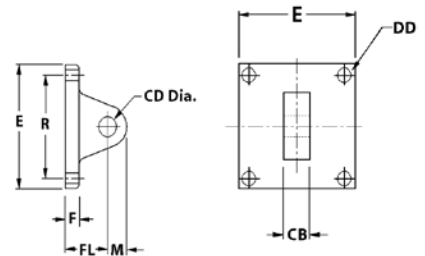

DMP Pivot Bracket  
1-1/8" Only

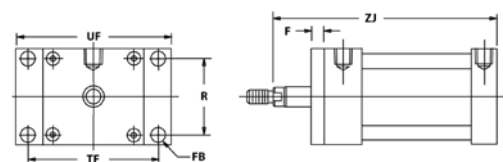

Rod End Flange Model FF\*

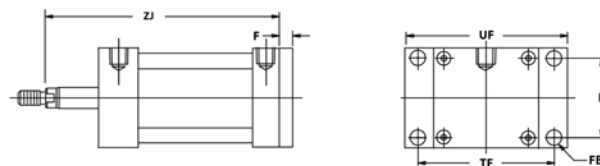

Blind End Flange Model FR\*

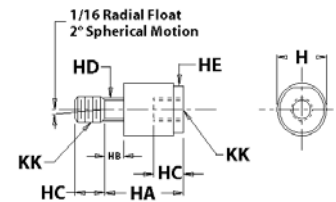

Self Aligning Rod Couplers

\*NOTE: For dimensions of tie rod extended models, consult factory.

# How To Order

## How To Order

### DM-112 x 10-FB-DR

Base Model
DM-075 = (3/4" Bore)
DM-112 = (1-1/8" Bore)

Stroke
State Fractional Strokes as decimals (i.e. 10.5)
<b>NOTE:</b> These cylinders use spacers for fractional stroke. For dimensioning, use the next even stroke. For true fractional stroke cylinders specify CT (i.e. , 10.5 CT)

Mounting
<b>NOTE:</b> DM-075 only available with FB Mount.
In addition to Models shown above, the DM-112 is also available in a Nose Mount (NS) configuration. Consult the factory for dimensional information.
<b>FF Option:</b> Front Flange - Plate extends beyond the front head. * On 1-1/8" bore cylinder, two flange bars replace the flange plate.

Options	
DR = Double Rod	

VI = Viton Seal	
-----------------	---





**Options below are only available on DM-112**

CF = Front Cushions	
CR = Rear Cushions	
CB = Cushions Both Ends	

IPF = Interpilots - Front Head	
IPR = Interpilots - Rear Head	
IPB* = Interpilots - Both Heads	

\* IPB must use -CT stroke option.

## How To Accessorize

	Bore Diameter	3/4"	1-1/8"
	Flex Rod Couplers	DMA-312	DMA-312
	Forged Rod Clevis	DMC-5	DMC-5
	Pivot Bracket	NA	DMP-7
	Clevis Bracket (with pin)	NA	DMR-7



## Features & Benefits

### Two Designs to Meet Application Demands

Bimba Dyna-Mation cylinders are available two design series, the DM1 and the DM2. The DM1 series incorporates tie-rod construction while the DM2 series cylinders are constructed with an extruded body design, making these cylinders better suited for wash down applications and clean environments.

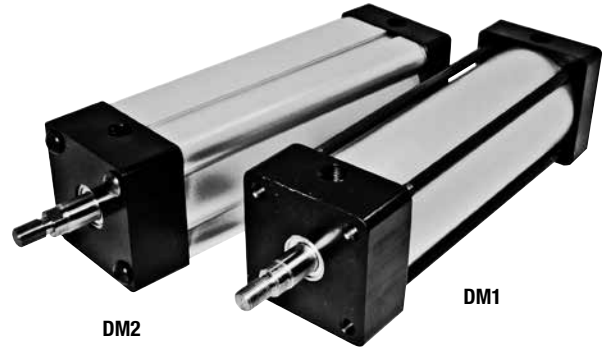

Cylinder Materials	
<b>Cylinder Heads</b>	Machined from solid aluminum bar stock and black anodized
<b>Tubes (DM1) &amp; Tube Extrusions (DM2)</b>	Aluminum hard anodized to 60 Rc (16 RMS finish)
<b>Pistons</b>	Solid high alloy aluminum and have a PTFE wear band
<b>Dynamic Seals</b>	High quality wear-compensating Buna-N block V rings
<b>Rods</b>	Hard chrome plated ground and polished steel Rod Wipers are PTFE
<b>Tie Rods (DM1)</b>	High tensile steel torqued to allow for flexure.

## Technical Data

Specifications	
Temp. Range:	-40° F to 250° F (-40° C to 121° C) (to 400° F (204° C) on request)
Lubrication:	Not necessary, but will extend cylinder life when operated with dry air.
Filtration:	A standard 40 micron filter placed upstream will prolong seal life.

## Operating Parameters

Bore Diameter	Thrust*	Thrust Mult.**	Rod Diameter (In.)	Max. Oper. Air Pressure
1-1/2"	177	1.77	5/8	250
2"	314	3.14	5/8	250
2-1/2"	491	4.91	5/8	250
3-1/4"	830	8.30	1	250
4"	1257	12.57	1	250
6"	2827	28.27	1-3/8	250

\* Pushing force of cylinder at 100 PSI inlet pressure. Pulling force will be about 10% less due to the displacement of the piston rod.

NOTE: Actual realizable thrust could be somewhat lower due to side loading and internal friction. It is best to oversize your cylinder by about 25% to assure smooth operation.

\*\* To determine thrust at other inlet pressures, multiply factor by the desired pressure.

NOTE: 6" bore only available in DM1 Series.

# How To Specify

## Product Information

### Dyna-Mation vs. HD Models

Dyna-Mation cylinders are designed to generate high performance in most applications. However, when operating conditions are severe, heavy duty models (HD Series, see pages 56-57) are recommended. The HD Series boasts the added benefits of a large hard-coated outboard rod bearing. The following profiles illustrate the differences of the rod end head in all three types of cylinders:



DM2  
Extruded Body Design with  
Internal Rod Bearing



DM1  
Internal Bronze Rod Bearing  
Tie Rod Design



HD1  
Heavy Duty Hard-Coated Rod Bearing

### Double Rod Cylinders

Cylinders having a common piston rod that protrudes from both ends are available in all bore sizes. In addition to providing a dual power source, double rod cylinders serve to minimize rod deflection and to facilitate the control and adjustment of rod travel. See page 30 for ordering instructions.

### Right Angle Flow Controls

Control the speed of your cylinders with Bimba Flow Control Valves. Right-angle flow controls can be found on page 105. For precise metering of air, see Bimba Dyla-Trol Valves on page 90.



### Specify Cushions for Shock Absorption

Adjustable cushions that decelerate the piston rod over the last 11/16" of stroke may be ordered in either or both ends of Dyna-Mation cylinders. They allow the user to set the degree of cushioning needed for each specific application.

A built-in check valve assures a fast getaway in the opposite direction. The tough cushion seal combines with the ultra-smooth control stem to provide years of reliable service.

## Mounting & Flanges



Pivot Mount



Clevis Mount



Rear Flange



Front Flange

## Product Information

### Dimensions

Bore	1-1/2	2	2-1/2	3-1/4	4	6
A	3/4	3/4	3/4	1-1/8	1-1/18	1-5/8
CA	1-1/2	1-1/2	1-1/2	2-1/16	2-1/16	1
CB	3/4	3/4	3/4	1-1/4	1-1/4	1-1/2
CD	1/2	1/2	1/2	3/4	3/4	1
CE	1-1/2	1-1/2	1-1/2	2-3/8	2-3/8	3-1/8
CW	1/2	1/2	1/2	5/8	5/8	3/4
D	1/2	1/2	1/2	7/8	7/8	1-1/8
DD	9/32	11/32	11/32	13/32	13/32	17/32
E	2	2-1/2	3	3-3/4	4-1/2	6-1/2
EE (NPTF)	1/4	1/4	1/4	1/2	1/2	3/4
F	3/8	3/8	1/2	5/8	5/8	3/4
FB	5/16	3/8	3/8	7/16	7/16	9/16
FL	1-1/8	1-1/8	1-1/8	1-7/8	1-7/8	2-1/4
G	1-7/16	1-7/16	1-7/16	1-11/16	1-11/16	2
J	15/16	15/16	15/16	1-3/16	1-3/16	1-1/2
K	1/8	5/32	5/32	3/16	3/16	3/16
KK	7/16-20	7/16-20	7/16-20	3/4-16	3/4-16	1-14
LD	3-5/8	3-5/8	3-3/4	4-1/4	4-1/4	5
M	5/8	5/8	5/8	7/8	7/8	1-1/8
MM	5/8	5/8	5/8	1	1	1-3/8
NA	19/32	19/32	19/32	31/32	31/32	1-5/16
NT	1/4-20	5/16-18	3/8-16	1/2-13	1/2-13	3/4-10
R	1-7/16	1-27/32	2-3/16	2-3/4	3-21/64	4-7/8
RT	1/4-28	5/16-24	5/16-24	3/8-24	3/8-24	1/2-20
SB	17/64	21/64	25/64	33/64	33/64	33/64
SJ	3/8	3/8	3/8	1/2	1/2	11/16
SM	3/8	3/8	3/8	1/2	1/2	11/64
SU	3/4	3/4	3/4	1	1	11/64
SW	3/16	3/16	1/4	1/4	1/4	7/64
TD	1	1	1	1	1	1-3/8
TF	2-3/4	3-3/8	3-7/8	4-11/16	5-7/16	7-5/8
TK	3/8	1/2	9/16	3/4	3/4	1-1/8
TL	1	1	1	1	1	1-5/8
TN	5/8	7/8	1-1/4	1-1/2	2-1/16	3-1/4
TS	2-3/4	3-1/4	3-3/4	4-3/4	5-1/2	7-7/8
UF	3-3/8	4-1/8	4-5/8	5-1/2	6-1/4	8-5/8
UT	4	4 1/2	5	5 3/4	6 1/2	9 1/4
W	1	1	1	1-3/8	1-3/8	1-5/8
XT	1-15/16	1-15/16	1-15/16	2-7/16	2-7/16	2-13/16
XG	1 3/4	1 3/4	1 3/4	2 1/4	2-1/4	2-13/16
H	1-1/4	1-1/4	1-1/4	1-3/4	1-3/4	2-1/2
HA	2	2	2	2-5/16	2-5/16	2-15/16
HB	1/2	1/2	1/2	1/2	1/2	1/2
HC	3/4	3/4	3/4	1-1/8	1-1/8	1-5/8
HD	5/8	5/8	5/8	31/32	31/32	1-3/8
HE	1	1	1	1-1/2	1-1/2	2-1/4
SN*	2-1/4	2-1/4	2-3/8	2-5/8	2-5/8	3-1/8
XC*	5-3/8	5-3/8	5-1/2	6-7/8	6-7/8	7-7/8
XD*	5-3/4	5-3/4	5-7/8	7-1/2	7-1/2	7-1/2
XJ*	4-1/8	4-1/8	4-1/4	5	4	5-7/8
ZJ*	4-5/8	4-5/8	4-3/4	5-5/8	5-5/8	6-5/8
ZM**	6-1/8	6-1/8	6-1/4	7-1/2	7-1/2	8-3/4

NOTE: \* Add Stroke Length to Dimensions Below \*\* Add Twice Stroke to ZM Dimension  
NOTE: For Inter-Pilot® port locations, see page 53.

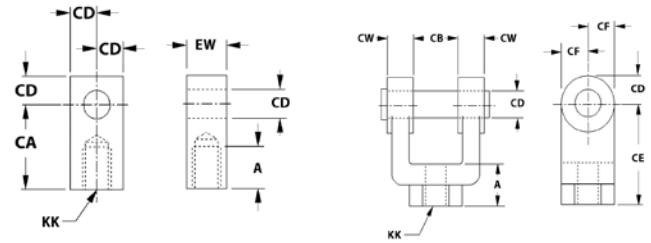

**DME Interchangeable Rod Eye**

**DMC Interchangeable Rod Clevis with Pin**

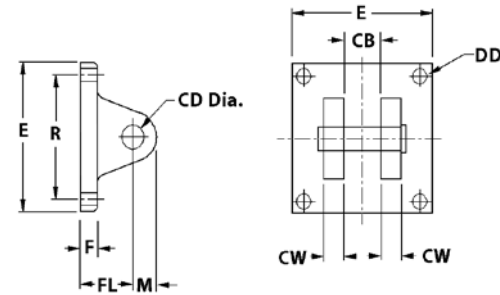

**DMR Clevis Bracket w/Pin (1.5" - 6" Bore Sizes)**

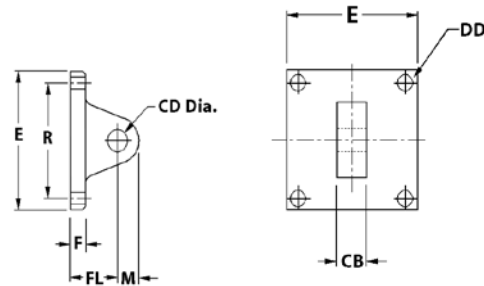

**DMP Pivot Bracket (1.5" - 4" Bore Sizes)**

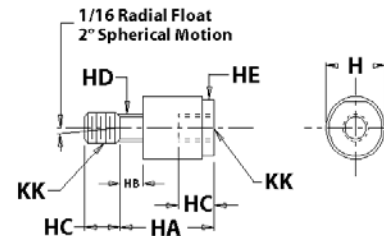

**Self Aligning Rod Couplers**

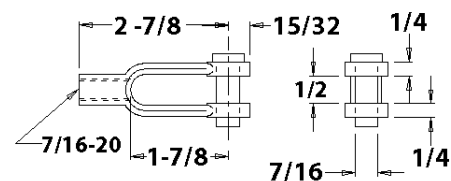

**DMC-1 Forged Rod Clevis w/Pin  
1-1/2" through 2-1/2" bores**

# How To Specify

## Product Information

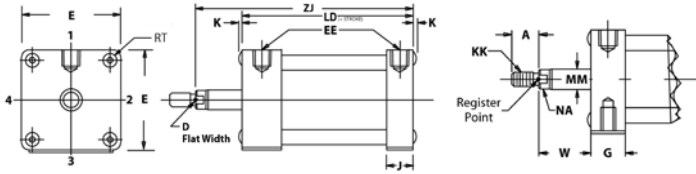

**Basic Cylinder**

NOTE: DM1 cylinders are constructed with sleeve nuts. For DM1, use RT; K does not exist. For DM2, use K; RT does not exist.

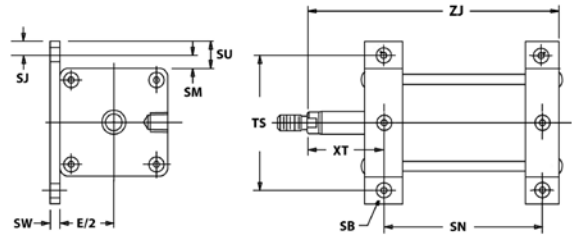

**Foot Mount Plate Model FT**

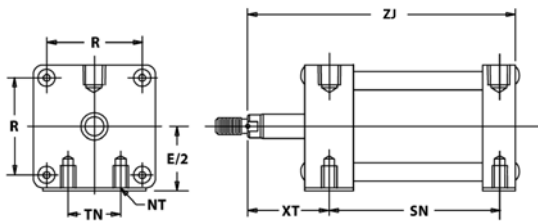

**Bottom Flush Model FB**

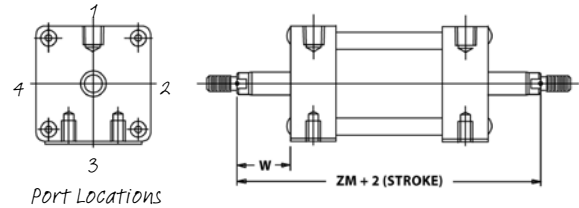

**Double Rod Model DR**

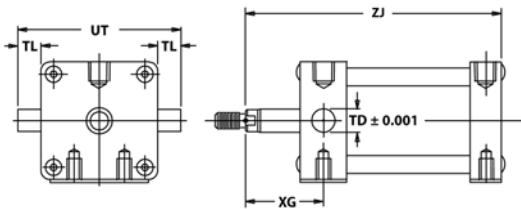

**Rod End Trunnion Model TF**

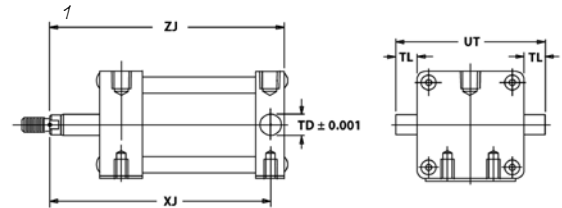

**Blind End Trunnion Model TR**

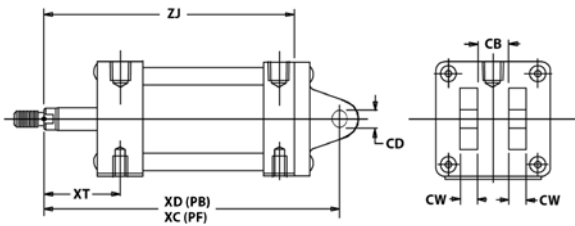

**Clevis Model PB and PF**

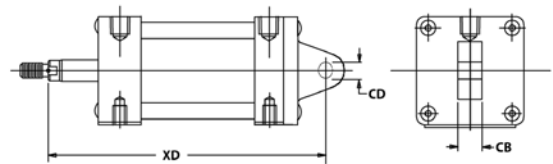

**Pivot Model PE**

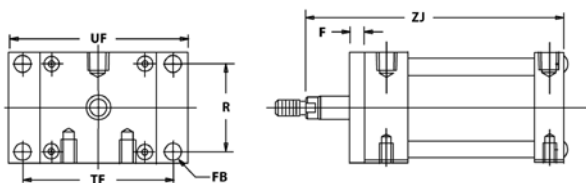

**Rod End Flange Model FH\***

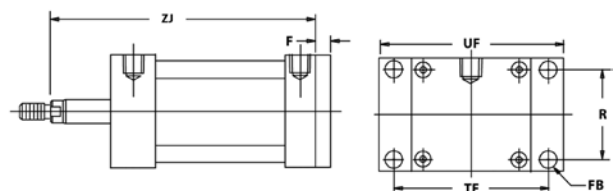

**Blind End Flange Model FR\***

## Accessories

Rod clevises, rod eyes, pivot brackets, clevis brackets, and pivot pins are available in each bore size to accomplish all four of the combinations illustrated below.



Rod Clevis and Pivot Bracket



Clevis Bracket and PE Cylinder



Rod Eye and Clevis Bracket



Pivot Bracket and PB Cylinder

### Pneumatic End-of-Stroke Sensors (Inter-Pilots®)

A miniature 3-way valve built into the cylinder head is actuated by the cylinder piston as it reaches the end of its stroke. Once contacted, the 3-way Inter-Pilot® valve emits an air signal. In this manner, sequencing is achieved without external limit switches and electric wiring.



Inter-Pilots® may be built into either or both cylinder heads. They are not for hydraulic use. Cylinder operating pressure must not exceed pressure used to feed the Inter-Pilot®.

### Inter-Pilot® Port Locations

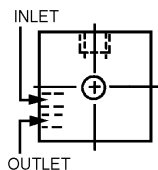

For 1-1/2" Bore Cylinders

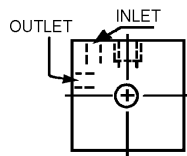

For 2"-4" Bore Cylinders

**NOTE:** Inter-Pilot® ports are 10-32.

### Rod Position Sensors

Solid State and Reed Switches allow the cylinder user to sense rod position anywhere within the stroke. Switches are available for both models. For the DM1, series the switch attaches to any of the four tie-rods. For the DM2 series, a dovetail slot runs along the cylinder tube to facilitate fast and accurate position setting.



Solid State effect technology provides contactless switching. With contactless switching there are no moving parts; therefore, reliability and life expectancy are greatly increased. Solid State switches come with built-in indicator lights (3 wire), reverse polarity and surge protection standard. Order either sinking or sourcing depending on logic systems requirements. They have an IP67 protection rating.

#### Technical Information

Operating Voltage:	5-28 DC	Working Temp:	23° F to 194° F (-5° C to 90° C)
Operating Time:	On 2 ms Off .1 ms	Repeatability:	.001 ms
Current Sinking: Load connected between output and positive supply.		Max. Switching Current:	.5A
Current Sourcing: Load is connected between output and common.			

### Reed

Bimba Reed Switches are epoxy encapsulated and economically priced for reliable low cost position sensing. Reed switches come with wire leads. LED (2 wire, 3m length) included.

#### Technical Information

Operating Voltage:	240 AC Max.	Working Temp:	67° F to 200° F (19° C to 93° C)
Switch Current:	.5 Amps Max. 10 Watts Max.	Operating Time:	On .5 ms Off .5 ms

### Pneumatic Stroke Completion Sensors (SCS)

Port mounted SCS valves emit an air signal when the cylinder rod has stopped, even if the piston has not contacted the end cap. SCS valves are ideal for use in situations where the full cylinder stroke is not used. SCS valves are available in 1/8", 1/4", 1/2" pipe sizes. See page 86-87.



### Self Aligning Rod Couplers

Rod couplers simplify cylinder alignment problems by compensating for 2Y angular error and 1/16" lateral misalignment on both extension and retraction strokes. Greater reliability is achieved by reducing cylinder and component wear. All components are heat treated for wear and corrosion resistance.



\* See page 44 for complete listing of Bimba's self aligning rod couplers.

Bore Diameter	1-1/2"	2"	2-1/2"	3-1/4"	4"	6"
Flex Rod Couplers	DMA-437	DMA-437	DMA-437	DMA-750	DMA-750	DMA-1000
Forged Rod Clevis	DMC-1	DMC-1	DMC-1	NA	NA	NA
Rod Clevis (NFPA Std.)	DMC-2	DMC-2	DMC-2	DMC-4	DMC-4	DMC-6
Machined Rod Eye (NFPA Std.)	DME-1	DME-1	DME-1	DME-2	DME-2	DME-3
Pivot Bracket	DMP-1	DMP-2	DMP-3	DMP-4	DMP-5	NA
Clevis Bracket (with Pin)	DMR-1	DMR-2	DMR-3	DMR-4	DMR-5	DMR-8

NOTE: DMP and DMR Pivot and Clevis brackets do not include any mounting hardware. See page 59 for mount kits.

# How To Order

## How To Order

### STEP 1

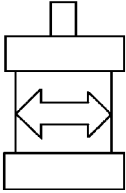

Select A Bore Size						
Bore	1-1/2"	2"	2-1/2"	3-1/4"	4"	6"
Force*	177	314	491	830	1257	2827
Models Available	DM1-150	DM1-200	DM1-250	DM1-325	DM1-400	DM1-600
	DM2-150	DM2-200	DM2-250	DM2-325	DM2-400	NA

\* Maximum force output at 100 PSI inlet pressure (in lbs.)

### STEP 2

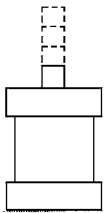



Choose Stroke Length						
Piston Rod Diameter						
Bore	1-1/2"	2"	2-1/2"	3-1/4"	4"	6"
Rod Diameter	5/8"	5/8"	5/8"	1"	1"	1-3/8"

**Non Standard Piston Rods:** Special rod threads or extensions are available. Please enclose a sketch of what you require.

### STEP 3

		Select A Mounting Style								
	Bimba Code	Bore Diameter						NFPA Code	Description	
		1-1/2"	2"	2-1/2"	3-1/4"	4"	6"			
	Flush Bottom	FB	•	•	•	•	•	•	MS-4	Four tapped holes on bottom of cylinder.
	Long Clevis	PB	•	•	•	•	•	•	MP-2	Two ears extend from rear head (clevis is detachable).
	Short Clevis	PF	•	•	•	•	•	NA	MP-1	Two ears extend from rear head (clevis is detachable).
	Pivot	PE	•	•	•	•	•	NA	MP-4	A single ear extends from rear head (pivot is detachable).
	Tie Rods Ext. Front	TIF	•	•	•	•	•	•	MX-3	All four tie-rods extend forward from cylinder face. Consult factory for rear extended tie-rods (or both ends).
	Front Flange NFPA Std.	FH	•	•	•	•	•	•	MF-1	Flange plate extends beyond the front head.
	Rear Flange	FR	•	•	•	•	•	•	MF-2	Flange plate extends beyond the rear head.
	Trunnion Front	TF	•	•	•	•	•	•	MT-1	Two pivot bars extend from two sides of front head. Not available with front Inter-Pilots® or front cushions.
	Trunnion Rear	TR	•	•	•	•	•	•	MT-2	Two pivot bars extend from two side of rear head. Not available with rear Inter-Pilots® or rear cushions.
	Foot	FT	•	•	•	•	•	•	Non Std.	A plate with two holes is mounted to the bottom of each head.

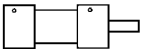
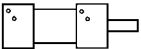
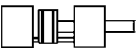
## How To Order

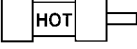
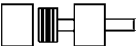
STEP 4		Select Cylinder Options							Description
		Bimba Code	Bore Diameter						
			1-1/2"	2"	2-1/2"	3-1/4"	4"	6"	
	Double Rod	DR	•	•	•	•	•	•	Rod extends through both heads: adds to cylinder rigidity
	Cushions (not available with Trunnion Mount)	Front (CF) Rear (CR) Both (CB)	•	•	•	•	•	•	Dampen the impact and sound that occur at stroke completion; cushions are adjustable.
	Inter-Pilots (not available with Trunnion Mount)	Front (IPF) Rear (IPR) Both (IPB)	•	•	•	•	•	•	Inter-Pilots emit an air signal at the end of each stroke. Integral with cylinder head. NOTE: Not available on hydraulic cylinders.
	Non-Rotating Rod (6" Max. Stroke)	NR	NA	NA	NA	•	•	•	Internal bar prevents piston and rod rotation.
	Non-Lube Seals	NL	•	•	•	•	•	•	Self-Lubricating seals are used in place of standard Buna-N seals. NOTE: Not available on hydraulic cylinders.
	High Temp. Seals (Viton)	VI	•	•	•	•	•	•	Viton seals are suitable for high temperature environments (400° F / 204° C max.)
	Magnetic Pistons	MP	•	•	•	•	•	•	Enables Reed and Solid State switches to sense piston location. <b>NOTE:</b> Reed switch/Solid State not available on all hydraulic cylinders. Contact Bimba.

## STEP 5

### Build A Model Number

When ordering Dyna-Mation cylinders, list the:

1. Model Number
2. Stroke
3. Mounting Style
4. Options (if needed)

# DM2-200 x 10-PB-CF

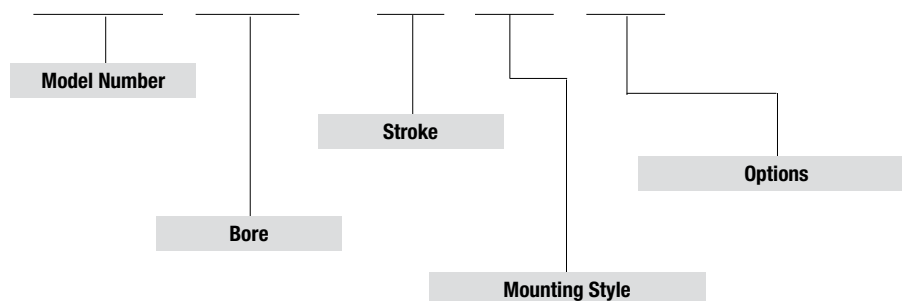

### Solid State Switches

Sourcing  
For DM1 series: CS-6200P  
For DM2 series: CS-7500P

Sinking  
For DM1 series: CS-6200N  
For DM2 series: CS-7500N

**Lead length:** 3 meters. Cylinders must have a magnetic piston (MP). For technical information, see page 49.

### Reed Switches

For DM1 series: CS-6200R  
For DM2 series: CS-7500R

Plain Wire Leads

Cylinders must have a magnetic piston (MP). For technical information, see page 61.

### Special Cylinders

We invite inquiries regarding non-standard cylinders. Please contact Bimba.

# Product Features

## Features & Benefits

### Cylinders For Abusive Conditions

Combining NFPA dimensional interchangeability and high quality components, the "HD1" Series offers excellent performance and long service life, even in the most severe of conditions.

### External Bearing Ensures Smooth Motion

HD1 cylinders are fitted with a heavy-duty external rod bearing in the rod end head. Teflon-impregnated and hardcoat anodized, this bearing ensures smooth rod motion while maintaining rod rigidity and stability. The entire rod gland and bearing may be quickly removed and replaced without disassembling the cylinder.



Cylinder Materials	
Rod Bearing	Teflon-impregnated, hardcoated aluminum
Heads	Machined from solid aluminum bar; black anodized
Tubes	Aluminum hard anodized to 60 Rc (16 RMS finish)
Piston	Solid high alloy aluminum and fitted with a PTFE Wear Band.
Piston Rod	High tensile ground and polished hard chrome plated steel
Piston & Rod Seals	Wear compensating Buna-N vee rings. Non-lube seals are also available (see Option NL).
Tube Seals	Buna-N O-rings
Rod Wiper	Dupont Teflon®
Tie Rods	High tensile steel torqued to allow for flexure.

NOTE: 6" Bore Cylinders do not have wear bands. (HD)

## Technical Data

Specifications	
Temp. Range:	-40° F to 250° F (-40° C to 121° C) (to 400° [204° C] F on request)
Lubrication:	For maximum cylinder life, non-detergent petroleum-based oil is recommended. Non-lube seals available.
Filtration:	Not essential, but a standard 40 micron filter placed upstream will prolong seal life.

## Operating Parameters

Bore Diameter	Thrust*	Thrust Mult.**	Rod Diameter (In.)	Max. Oper. Air Pressure
1-1/2"	177	1.77	5/8 or 1"	250
2"	314	3.14	5/8 or 1"	250
2-1/2"	491	4.91	5/8 or 1"	250
3-1/4"	830	8.30	1 or 3/8"	250
4"	1257	12.57	1 or 3/8"	250
6"	2827	28.27	1-3/8 or 1-3/4"	250

\* Pushing force of cylinder at 100 PSI inlet pressure. Pulling force will be about 10% less due to the displacement of the piston rod.

**NOTE:** Actual realizable thrust could be somewhat lower due to side loading and internal friction. It is best to oversize your cylinder by about 25% to assure smooth operation.

\*\* To determine cylinder thrust at other inlet pressures, multiply this factor times the desired inlet pressure.



## Product Information

### Dimensions

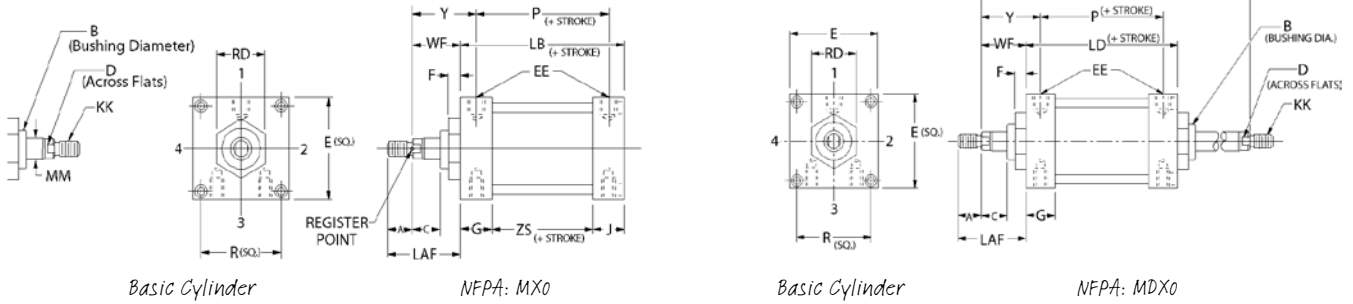

• EE Dimension is NPTF

\* 6" bore HD cylinders have a rear tie rod nut, shown below as the "K" dimension. K = 7/16"

Bore	MM Rod	A	B	C	D	E	EE	F	G	J	K	KK	LAF	LB	LD	P	R	WF	Y	ZS	ZM	RD
1-1/2	5/8	3/4	1-1/8	3/8	1/2	2	1/4	3/8	1-7/16	15/16	-	7/16-20	1-3/4	3-5/8	4-1/8	2-1/4	1-7/16	1	1-15/16	1-1/4	6-1/8	1-1/8
	1	1-1/8	1-1/2	5/8	7/8							3/4-16	2-1/2									
2	5/8	3/4	1-1/8	3/8	1/2	2-1/2	1/4	3/8	1-7/16	15/16	-	7/16-20	1-3/4	3-5/8	4-1/8	2-1/4	1-27/32	1	1-15/16	1-1/4	6-1/8	1-1/8
	1	1-1/8	1-1/2	5/8	7/8							3/4-16	2-1/2									
2-1/2	5/8	3/4	1-1/8	3/8	1/2	3	1/4	3/8	1-7/16	15/16	-	7/16-20	1-3/4	3-3/4	4-1/4	2-3/8	2-3/16	1	1-15/16	1-3/8	6-1/4	1-1/8
	1	1-1/8	1-1/2	5/8	7/8							3/4-16	2-1/2									
3-1/4	1	1-1/8	1-1/2	1/2	7/8	3-3/4	1/2	5/8	1-11/16	1-3/16	-	3/4-16	2-1/2	4-1/4	4-3/4	2-5/8	2-3/4	1-3/8	2-7/16	1-3/8	7-1/2	1-3/4
	1-3/8	1-5/8	2	5/8	1-1/8							1-14	3-1/4									
4	1	1-1/8	1-1/2	1/2	7/8	4-1/2	1/2	5/8	1-11/16	1-3/16	-	3/4-16	2-1/2	4-1/4	4-3/4	2-5/8	3-21/64	1-3/8	2-7/16	1-3/8	7-1/2	1-3/4
	1-3/8	1-5/8	2	5/8	1-1/8							1-14	3-1/4									
6	1-3/8	1-5/8	2	5/8	1-1/8	6-1/2	3/4	3/4	2	1-1/2	7/16	1-14	3-1/4	5	5-1/2	3-1/8	4-7/8	1-5/8	2-13/16	1-1/2	8-3/4	2
	1-3/4	2	2-3/8	3/4	1-1/2							1-1/4-12	3-7/8									

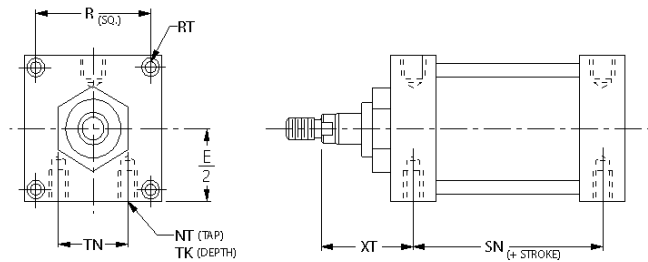

Rear, Front & Bottom Tapped (FB)

NFPA: MS4

Bore	MM Rod Diameter	NT	RT	TK	TN	SN	XT
1-1/2	5/8	1/4-20	1/4-28	3/8	5/8	2-1/4	1-15/16
	1						2-5/16
2	5/8	5/16-18	5/16-24	1/2	7/8	2-1/4	1-15/16
	1						2-5/16
2-1/2	5/8	3/8-16	5/16-24	9/16	1-1/4	2-3/8	1-15/16
	1						2-5/16
3-1/4	1	1/2-13	3/8-24	3/4	1-1/2	2-5/8	2-7/16
	1-3/8						2-11/16
4	1	1/2-13	3/8-24	3/4	2-1/16	2-5/8	2-7/16
	1-3/8						2-11/16
6	1-3/8	3/4-10	1/2-20	1-1/8	3-1/4	3-1/8	2-13/16
	1-3/4						3-3/16

# How To Specify

## Product Information

### Dimensions

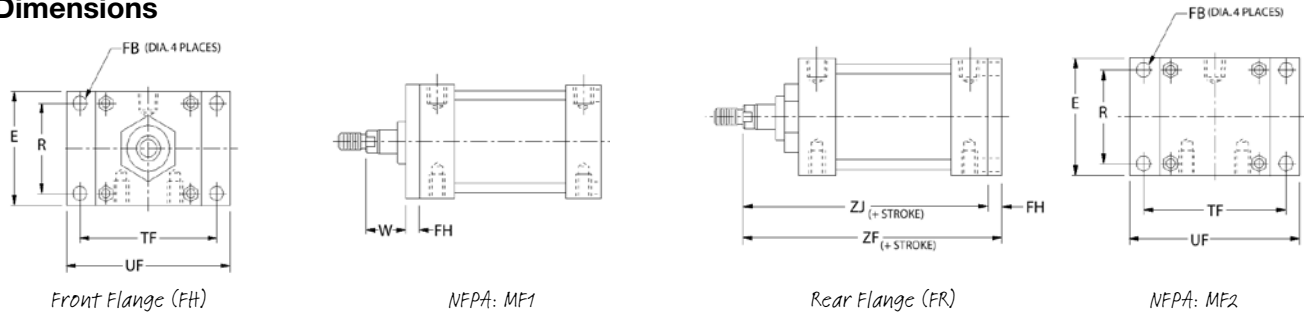

Bore	MM Rod Diameter	E	FB (BOLT)	FH	R	TF	UF	W	ZJ	ZF
1-1/2	5/8	2	5/16	3/8	1-7/16	2-3/4	3-3/8	5/8	4-5/8	5
	1							5	5-3/8	
2	5/8	2-1/2	3/8	3/8	1-27/32	3-3/8	4-1/8	5/8	4-5/8	5
	1							5	5-3/8	
2-1/2	5/8	3	3/8	3/8	2-3/16	3-7/8	4-5/8	5/8	4-3/4	5-1/8
	1							5-1/8	5-1/2	
3-1/4	1	3-3/4	7/16	5/8	2-3/4	4-11/16	5-1/2	3/4	5-5/8	6-1/4
	1-3/8							5-7/8	6-1/2	
4	1	4-1/2	7/16	5/8	3-21/64	5-7/16	6-1/4	3/4	5-5/8	6-1/4
	1-3/8							5-7/8	6-1/2	
6	1-3/8	6-1/2	9/16	3/4	4-7/8	7-5/8	8-5/8	7/8	6-5/8	7-3/8
	1-3/4							1-1/8	6-7/8	7-5/8

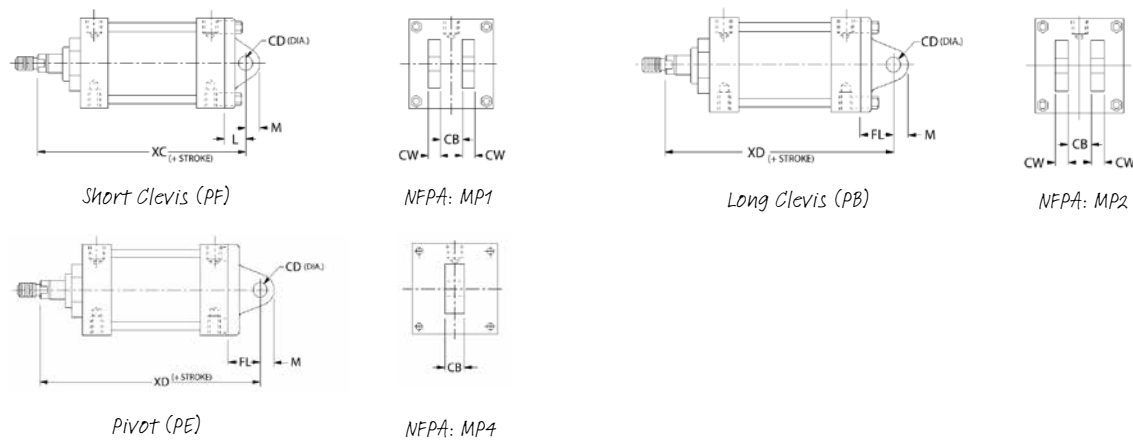

Bore	MM Rod Diameter	CB	CD	CW	FL	L	M	XC	XD
1-1/2	5/8	3/4	1/2	1/2	1-1/8	3/4	5/8	5-3/8	5-3/4
	1							6-1/8	
2	5/8	3/4	1/2	1/2	1-1/8	3/4	5/8	5-3/8	5-3/4
	1							6-1/8	
2-1/2	5/8	3/4	1/2	1/2	1-1/8	3/4	5/8	5-1/2	5-7/8
	1							5-7/8	6-1/4
3-1/4	1	1-1/4	3/4	5/8	1-7/8	1-1/4	7/8	6-7/8	7-1/2
	1-3/8							7-1/8	5-3/4
4	1	1-1/4	3/4	5/8	1-7/8	1-1/4	7/8	6-7/8	7-1/2
	1-3/8							7-1/8	7-3/4
6	1-3/8	1-1/2	1	3/4	2-1/4 Clevis	-	1-1/8	NA	8-7/8
	1-3/4							9-1/8	

## Product Information

### Dimensions

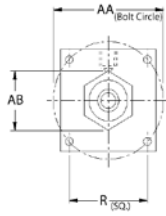

Extended Tie Rods, Both Ends (TIB)

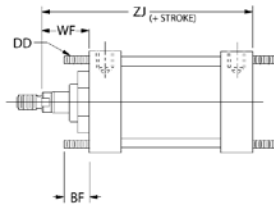

NFPA: MX1

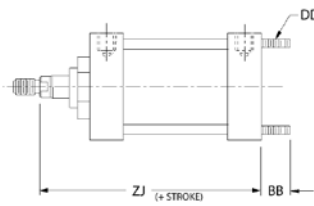

Back End (TIR)

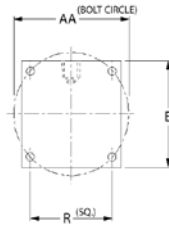

NFPA: MX2

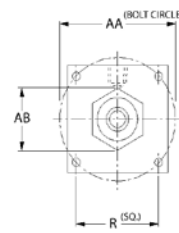

Rod End (TIF)

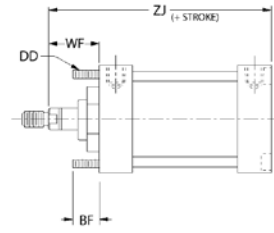

NFPA: MX3

Bore	MM Rod Diameter	AA	BB	AB	BF	DD	R	ZJ
1-1/2	5/8	2.02	1	1-5/16	1-3/8	1/4-28	1-7/16	4-5/8
	1							5
2	5/8	2.6	1-1/8	1-5/16	1-1/2	5/16-24	1-27/32	4-5/8
	1							5
2-1/2	5/8	3.1	1-1/8	1-3/4	1-1/2	5/16-24	2-3/16	4-3/4
	1							5-1/8
3-1/4	1	3.9	1-3/8	2-1/32	2	3/8-24	2-3/4	5-5/8
	1-3/8							5-7/8
4	1	4.7	1-3/8	2-1/32	2	3/8-24	3-21/64	5-5/8
	1-3/8							5-7/8
6	1-3/8	6.9	1-13/16	2-5/16	2-9/16	1/2-20	4-7/8	6-5/8
	1-3/4							6-7/8

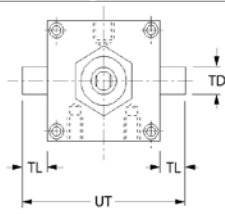

Front Trunnion (TF)

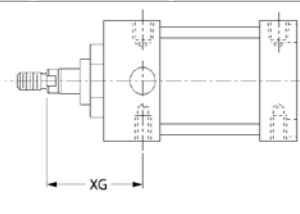

NFPA: MT1

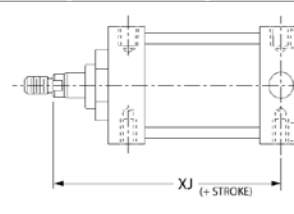

Rear Trunnion

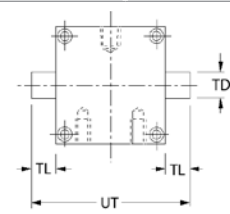

NFPA: MT2

Bore	MM Rod Diameter	TD ±0.01	TL	UT	XG	XJ
1-1/2	5/8	1	1	4	1-3/4	4-1/8
	1				2-1/8	4-1/2
2	5/8	1	1	4-1/2	1-3/4	4-1/8
	1				2-1/8	4-1/2
2-1/2	5/8	1	1	5	1-3/4	4-1/4
	1				2-1/8	4-5/8
3-1/4	1	1	1	5-3/4	2-1/4	5
	1-3/8				2-1/2	5-1/4
4	1	1	1	6-1/2	2-1/4	5
	1-3/8				2-1/2	5-1/4
6	1-3/8	1-3/8	1-3/8	9-1/4	2-5/8	5-7/8
	1-3/4				2-7/8	6-1/8

# How To Specify

## Product Information

### Dimensions

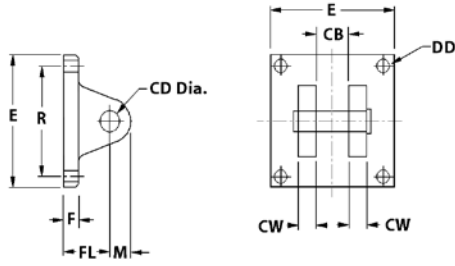

Clevis Bracket

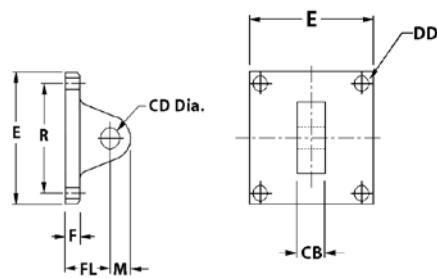

Pivot Bracket

Bore	CB	CD	CW	DD	E	FL	M	R
1-1/2	3/4	1/2	1/2	9/32	2	1-1/8	5/8	1-7/16
2	3/4	1/2	1/2	11/32	2-1/2	1-1/8	5/8	1-27/32
2-1/2	3/4	1/2	1/2	11/32	3	1-1/8	5/8	2-3/16
3-1/4	1-1/4	3/4	5/8	13/32	3-3/4	1-7/8	7/8	2-3/4
4	1-1/4	3/4	5/8	13/32	4-1/2	1-7/8	7/8	3-21/64
6	1-1/2	1	3/4	17/32	6-1/2	2-1/4	1-1/8	4-7/8

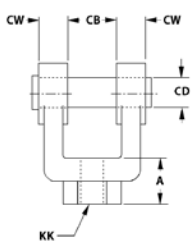

Rod Clevis

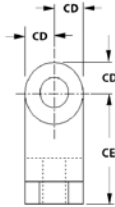

Rod Eye

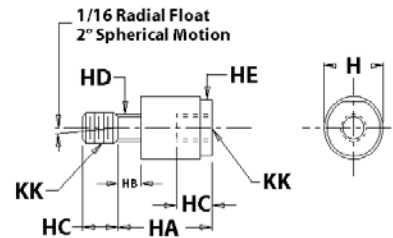
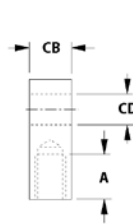
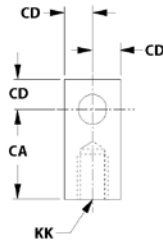

Rod Coupler

Part # Rod Clevis Rod Eye Rod Coupler	Cylinder	A	CA	CB	CD	CE	CW	KK	H	HA	HB	HC	HD	HE
DMC-2 DME-1 DMA-437	HD1-150 HD1-200 HD1-250	3/4	1-1/2	3/4	1/2	1-1/2	1/2	7/16-20	1-1/4	2	1/2	3/4	5/8	1-1/8
DMC-4 DME-2 DMA-750	HD1-150 OR HD1-200 OR HD1-250 OR HD1-325 HD1-400	1-1/8	2-1/16	1-1/4	3/4	2-3/8	5/8	3/4-16	1-3/4	2-5/16	5/16	1-1/8	31/32	1-1/2
DMC-6 DME-3 DMA-1000	HD1-325 OR HD1-400 OR HD-600	1-5/8	2-13/16	1-1/2	1	3-1/8	3/4	1-14	2-1/2	2-15/16	1/2	1-5/8	1-3/8	2-1/4
DMC-7 DME-7 DMA-1250	HD-600 OR	1-5/8	3-7/16	2	1-3/8	4-1/8	1	1 1/4-12	2-1/2	2-15/16	1/2	1-5/8	1-3/8	2-1/4

## Accessories

### Customize Your Cylinder

The HD1 Series offers numerous accessories and design options. With hundreds of possible combinations available, you can “design” your own cylinder for any application.

#### Cushions (CR, CF, CB)

For end-of-stroke load deceleration, specify cushions in either or both ends of your cylinder. Cushions decelerate the piston rod over the last 11/16” of stroke. Adjustable, they allow you to set the degree of cushioning needed for each specific application.

A built-in check valve assures a fast getaway in the opposite direction. A pre-lubricated nitrile cushion seal provides years of reliable service.

**NOTE:** Cushions are not recommended on hydraulic cylinders.

#### Double Rod (DR)

Double rod cylinders have a common piston rod that protrudes from both ends of the cylinder. In addition to providing a dual power source, double rod cylinders serve to minimize rod deflection and to facilitate the control and adjustment of rod travel.

#### Inter-Pilots® (IP)

Bimba’s Inter-Pilot® is a miniature 3-way valve built in the cylinder head. Actuated by the cylinder’s piston as it reaches the end of its stroke, the valve emits an air signal. Thus, sequencing is achieved without external limit switches and electric wiring.



Inter-Pilots may be built into either or both cylinder heads. They are not for hydraulic use. Cylinder operating pressure must not exceed pressure used to feed the Inter-Pilot®.

#### Inter-Pilot® Port Locations (Port Size = 10-32):

Inter-Pilot port location style that is offered with each cylinder head.

Bore (Either Head)	1-1/2"	2"	2-1/2"	3-1/4"	4"	6"
Non-Cushion	2	1	1	1	1	3
Cushion	2	1	1	1	1	3

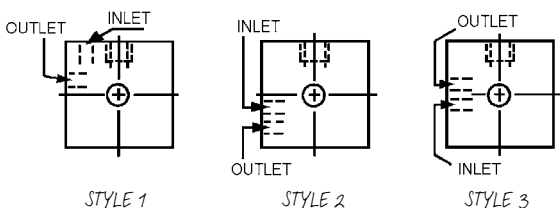

#### Non-Rotating Rod (NR)

For prevention of piston and rod rotation, an internal rod is embedded internally into both cylinder heads. This rod also passes through the piston and acts as a linear guide for the piston. **NOTE:** NR option available on 3-1/4”, 4” and 6” bore cylinders only.

#### Viton™ Seals (VI)

For high temperature environments, Viton™ seals can be specified to replace standard Buna-N seals. While HD1 cylinders are normally rated to 250° F (121° C), cylinders with Viton seals are rated to 400° F (204° C).

#### Low Breakaway Option (NL)

For non-lube service, polyurethane seals replace standard piston and rod seals. These specially formulated seals have an inherent lubricity that provides low breakaway between the piston and tube.

#### Magnetic Piston (MP)

If you will be using either Solid State or Reed switches for sensing rod position, you will need to order your cylinder with a magnetic piston.

Bimba’s Solid State and Reed switches allow the cylinder user to sense rod position anywhere within the stroke. They emit an electrical signal when the magnetized piston reaches a point opposite their location. Tie rod mounting facilitates fast and accurate position setting.

# How To Accessorize

## Accessories

### Oversized Rod (OR)

Available on all models: on the HD1-150, 200 and 250, you can order a 1" rod diameter rather than the standard 5/8" diameter; the HD1-325 and HD1-400 with a 1-3/8" rather than the standard 1"; and the HD1-600 with a 1-3/4" rather than the standard 1-3/8".

### Pneumatic Stroke Completion Sensors (SCS)

Port mounted SCS valves emit an air signal when the cylinder rod has stopped, even if the piston has not contacted the end cap. Ideal for use in situations where the full cylinder stroke is not used. See page 86-87.

### Self Aligning Rod Couplers

Rod couplers simplify cylinder alignment problems by compensating for 2° angular error and 1/16" lateral misalignment on both extension and retraction strokes. Greater reliability is achieved by reducing cylinder and component wear. All components are heat treated for wear and corrosion resistance. See page 44 for complete listing of Bimba's self aligning rod couplers.



### Flow Control Valves





**Dyla-Trol®** - For unprecedented smoothness in cylinder speed control, use Bimba's Dyla-Trol® valves with a perfectly tapering flow. Where needle type flow controls generate turbulence as they close, Dyla-Trol® maintains an even 360 laminar flow regardless of the setting. See page 90 for more information.



### Right Angle Flow Controls (RAF)

- RAF flow controls feature push-in-fittings, pre-applied Teflon® based thread sealant, a recessed screw driver adjustment and convenient swivel for ease of tubing alignment. See page 111.

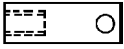

	Bore Diameter	Rod Size	1-1/2"	2"	2-1/2"	3-1/4"	4"	6"
	Flex Rod Couplers	STD	DMA-437	DMA-437	DMA-437	DMA-750	DMA-750	DMA-1000
		OR	DMA-750	DMA-750	DMA-750	DMA-1000	DMA-1000	DMA-1250
	Forged Rod Clevis	STD	DMC-1	DMC-1	DMC-1	NA	NA	NA
		OR	NA	NA	NA	NA	NA	NA
	Rod Clevis (NFPA Std.)	STD	DMC-2	DMC-2	DMC-2	DMC-4	DMC-4	DMC-6
		OR	DMC-4	DMC-4	DMC-4	DMC-6	DMC-6	DMC-7
	Machined Rod Eye (NFPA Std.)	STD	DME-1	DME-1	DME-1	DME-2	DME-2	DME-3
		OR	DME-2	DME-2	DME-2	DME-3	DME-3	NA
	Pivot Bracket Kit	ALL	HD40-150	HD40-200	HD40-250	HD40-325	HD40-400	NA
	Short Clevis (with pin)	ALL	HD35S-150	HD35S-200	HD35S-250	HD35S-325	HD35S-400	NA
Clevis Bracket Mounting Kits	Long Clevis (with pin)	ALL	HD35-150	HD35-200	HD35-250	HD35-325	HD35-400	DMR-8 Bracket Only
	Flange Mounting Kits (for front or rear flanges)	ALL	HD45-150	HD45-200	HD45-250	HD45-325	HD45-400	NA

**NOTE:** All kits include mounting hardware. For DMC-1 dimensions, see page 51. For all others, see page 60.

## How To Order

### STEP 1

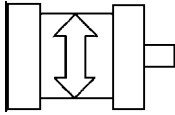

Select A Bore Size						
Bore	1-1/2"	2"	2-1/2"	3-1/2"	4"	6"
Force*	177	314	491	830	1257	2827
Model	HD1-150	HD1-200	HD1-250	HD1-325	HD1-400	HD1-600

\* Maximum force output at 100 PSI inlet pressure (in lbs.)

### STEP 2

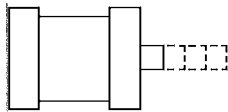

Choose Stroke Length						
Piston Rod Diameter						
Bore Diameter	1-1/2"	2"	2-1/2"	3-1/4"	4"	6"
Rod Diameter	5/8 or 1"	5/8 or 1"	5/8 or 1"	1 or 1-3/8"	1 or 1-3/8"	1-3/8 or 1-3/4"

**Non Standard Piston Rods:** Special rod threads or extensions are available. Please enclose a sketch of what you require.

### STEP 3

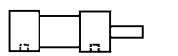

Flush Bottom/  
Front Rear

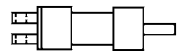

Long Clevis

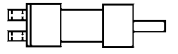

Short Clevis

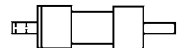

Pivot

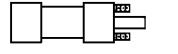

Tie Rods Ext. Front

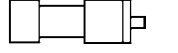

Front Flange  
NFFA Std.

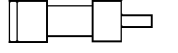

Rear Flange

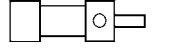

Trunnion Front

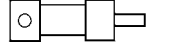

Trunnion Rear

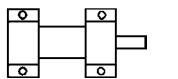





Foot

		Select A Mounting Style								
	Bimba Code	Bore Diameter						NFFA Code	Description	
		1-1/2"	2"	2-1/2"	3-1/4"	4"	6"			
	FB	•	•	•	•	•	•	MS-4	Four tapped holes in bottom and in both cylinder faces (front and rear). Rear sleeve nuts standard.	
	PB	•	•	•	•	•	•	MP-2	Two ears extend from rear head (clevis is detachable).	
	PF	•	•	•	•	•	NA	MP-1	Two ears extend from rear head (clevis is detachable).	
	PE	•	•	•	•	•	NA	MP-4	A single ear extends from rear head (pivot is detachable).	
	TIF	•	•	•	•	•	•	MX-3	All four tie-rods extend forward from cylinder face. Consult factory for rear extended tie-rods (or both ends).	
	FH	•	•	•	•	•	•	MF-1	Flange plate extends beyond the thicker front head.	
	FR	•	•	•	•	•	•	MF-2	Flange plate extends beyond the rear head.	
	TF	•	•	•	•	•	•	MT-1	Two pivot bars extend from two sides of front head. Not available with front Inter-Pilots® or front cushions.	
	TR	•	•	•	•	•	•	MT-2	Two pivot bars extend from two side of rear head. Not available with rear Inter-Pilots® or rear cushions.	
	FT	•	•	•	•	•	•	Non Std.	A plate with two holes is mounted to the bottom of each head.	

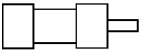
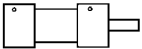
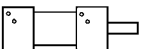
# How To Order

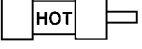
## How To Order

STEP 4		Select Cylinder Options								Description
		Bimba Code	Bore Diameter							
			1-1/2"	2"	2-1/2"	3-1/4"	4"	6"		
	Double Rod	DR	•	•	•	•	•	•	Rod extends through both heads: adds to cylinder rigidity	
	Oversized Rod	ODR	•*	•	•	•	•	•	Standard rod is replaced by larger diameter rod.	
	Cushions (not available with Trunnion Mount)	Front (CF) Rear (CR) Both (CB)	•*	•	•	•	•	•	Dampen the impact and sound that occur at stroke completion. Adjustable. NOTE: Not available on hydraulic cylinders.	
	Inter-Pilots (not available with Trunnion Mount)	Front (IPF) Rear (IPR) Both (IPB)	•*	•	•	•	•	•	Inter-Pilots® emit an air signal at the end of each stroke. Integral with cylinder head. NOTE: Not available on hydraulic cylinders.	
	Non-Rotating Rod (6" Max. Stroke)	NR	NA	NA	NA	•	•	•	Internal bar prevents piston and rod rotation.	
	Non-Lube Seals	NL	•	•	•	•	•	•	Self-Lubricating seals are used in place of standard Buna-N seals. NOTE: Not available on hydraulic cylinders.	
	High Temp. Seals (Viton)	VI	•	•	•	•	•	•	Viton seals are suitable for high temperature environments (400° F / 204° C max.)	
	Magnetic Pistons	MP	•	•	•	•	•	•	Enables Reed and Solid State switches to sense piston location. <b>NOTE:</b> Reed switch/Solid State not available on all hydraulic cylinders. Contact Bimba.	

\* Cushions or Inter-Pilots® are not available on the rod end head of 1-1/2" bore cylinders with oversized rod.

### STEP 5

### Build A Model Number

When ordering Dyna-Mation cylinders, list the:

1. Base Model
2. Stroke
3. Mounting Style
4. Options (if needed)

# HD1-200 x 10-PB-CF

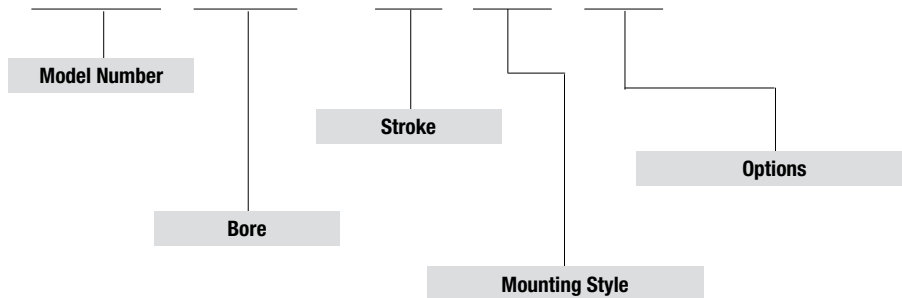

#### Solid State Switches

Sourcing  
For DM1 series: CS-6200P  
For DM2 series: CS-7500P

Sinking  
For DM1 series: CS-6200N  
For DM2 series: CS-7500N

**Lead length:** 3 meters. Cylinders must have a magnetic piston (MP). For technical information, see page 49.

#### Reed Switches

For DM1 series: CS-6200R  
For DM2 series: CS-7500R  
Plain Wire Leads

Cylinders must have a magnetic piston (MP). For technical information, see page 49.

#### Special Cylinders

We invite inquiries regarding non-standard cylinders. Please contact Bimba.



## Features & Benefits

### Large Bore Cylinders for Abusive Conditions

Combining NFPA dimensional interchangeability and high quality components, the HD Large Bore Series offers excellent performance and long service life, even in the most severe of conditions. Bimba offers 5", 8", 10" and 12" bore sizes to meet your needs.

Cylinder Materials	
<b>Floating Rod Bushing</b>	Precision machined from 150,000 PSI rated graphite-filled cast iron and PTFE coated to reduce friction and extend cycle life. Bushing design "traps" lubrication in effective bearing area.
<b>Head, Cap &amp; Retainer</b>	Precision machined from high strength 6061-T6 aluminum alloy.
<b>Cylinder Tube</b>	Precision machined from 6063-T6832 high tensile aluminum alloy and hard coat to 60 Rc for wear resistance and extended cycle life.
<b>Piston Rod</b>	Precision machined from high yield, polished and hard chrome plated steel.
<b>Piston &amp; Rod Seals</b>	Heavy lip design Carboxilated Nitrile construction. Seals are pressure activated and wear compensating for long life. (Self lubricating material.)
<b>Rod Wiper</b>	Abrasion resistant urethane provides aggressive wiping action in all environments. External lip design prevents debris from entering cylinder.
<b>Piston</b>	Precision machined from 6061-T651 alloy aluminum. Provides an excellent bearing surface for extended cylinder life.
<b>Tie Rods</b>	Pre-stressed high carbon steel tie rod construction eliminates axial loading of cylinder tube and maintains compression on tube and seals.
<b>Permanent Lubrication</b>	Permanently lubricated with Magna-Lube G PTFE-based grease on all internal components. This is a non-migratory type high performance grease providing outstanding service life. No additional lubrication is required.

## Technical Data

### Operating Parameters

Bore Diameter	Thrust*	Thrust Mult.**	Rod Diam.	Max. Operating Pressure Air
5"	1964	19.64	1" or 1-3/8"	250 PSI
8"	5027	50.27	1-3/8" or 1-3/4"	200 PSI
10"	7854	78.54	1-3/4" or 2"	200 PSI
12"	11310	113.1	2" or 2-1/2"	200 PSI

\*Pushing force of cylinder at 100 PSI inlet pressure. Pulling force will be about 10% less due to the displacement of the piston rod. (Use 15% when Oversized Rods are chosen.) **NOTE:** Actual realizable thrust could be somewhat lower due to side loading and internal friction. It is best to oversize your cylinder by about 25% to assure smooth operation.

\*\*To determine cylinder thrust at other inlet pressures, multiply this factor times the desired inlet pressure.

# How To Specify

## Product Information

### Dimensions

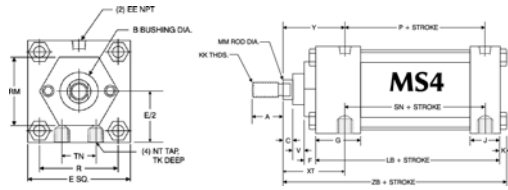

Bottom Flush Model FB

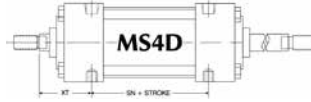

Double Rod Model DR

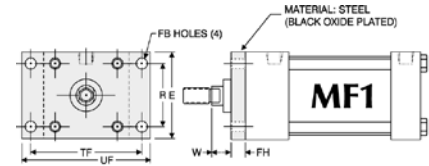

Rod End Flange Model FH (5" Bore Only)

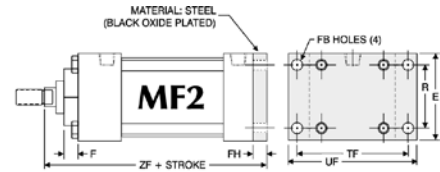

Blind End Flange Model FR (5" Bore Only)

Bore	Rod Dia.	A	AA	B	BB	C	CB	CD	CW	DD	E	EE	F	FB	FH	FL	G	J	K	KK	L	LB	M	MM	NT	P	R	RM	SB
5	1 STD	1.13	5.8	1.50	1.81	.50	1.25	.75	.63	.50-20	5.50	.50	.63	.56	.63	1.88	1.75	1.25	.44	.75-16	1.25	4.50	.88	1	63-11	3	4.10	2.75	.81
	1.38 OR	1.63	5.8	2	1.81	.63	1.25	.75	.63	.50-20	5.50	.50	.63	.56	.63	1.88	1.75	1.25	.44	1-14	1.25	4.50	.88	1.38	63-11	3	4.10	3.50	.81
8	1.38 STD	1.63	9.1	2	2.31	.63	1.50	1	.75	.63-18	8.50	.75	.63	.69	.63	NA	2	1.50	.56	1-14	1.50	5.13	1	1.38	.75-10	3.38	6.44	3.50	.81
	1.75 OR	2	9.1	2.38	2.31	.75	1.50	1	.75	.63-18	8.50	.75	.63	.69	.63	NA	2	1.50	.56	1.25-12	1.50	5.13	1	1.75	.75-10	3.38	6.44	3.50	.81
10	1.75 STD	2	11.2	2.38	2.69	.75	2	1.38	1	.75-16	10.6	1	.63	.81	.63	NA	2.25	2	.69	1.25-12	2.13	6.38	1.38	1.75	1-8	4.31	7.92	3.50	-
	2 OR	2.25	11.2	2.63	2.69	.88	2	1.38	1	.75-16	10.6	1	.75	.81	.75	NA	2.25	2	.69	1.50-12	2.13	6.38	1.38	2	1-8	4.31	7.92	5	-
12	2 STD	2.25	13.3	2.63	2.69	.88	2.50	1.75	1.25	.75-16	12.75	1	.75	.81	.75	NA	2.25	2	.69	1.50-12	2.25	6.88	1.75	2	1-8	4.81	9.40	5	-
	2.50 OR	3	13.3	3.13	2.69	1	2.50	1.75	1.25	.75-16	12.75	1	.75	.81	.75	NA	2.25	2	.69	1.88-12	2.25	6.88	1.75	2.50	1-8	4.81	9.40	5	-

### Mounting Options

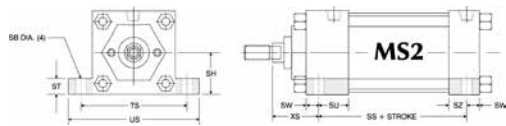

Foot Mount Model FT

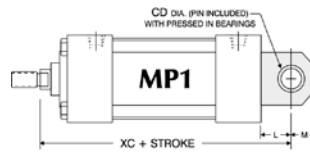

Clevis Mount Model PB

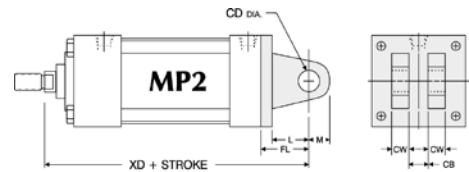

Clevis Mount Model PF

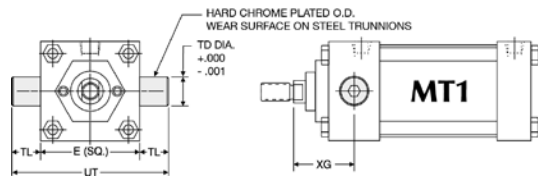

Trunnion Front Mount Model TF

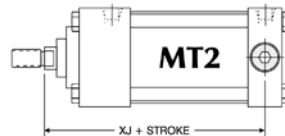

Trunnion Rear Mount Model TR

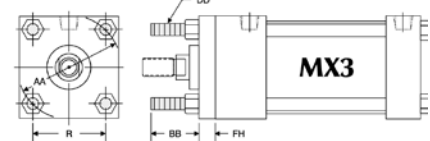

Tie Rods Extended Front Model TIF

NOTE: Consult factory for additional mounting options.

Bore	Rod Dia.	SH	SN	SS	ST	SU	SW	SZ	TD	TE	TF	TK	TL	TN	TS	UF	UM	US	UT	V	W	XC	XD	XG	XJ	XS	XT	Y	ZB	ZF
5	1 STD	2.75	2.88	3.73	1	1.06	.69	.56	1	-	6.63	1	1	2.69	6.88	7.63	8.25	8.25	7.50	.25	.75	7.13	7.75	2.25	5.25	2.06	2.44	2.38	6.31	6.50
	1.38 OR	2.75	2.88	3.73	1	1.06	.69	.56	1	-	6.63	1	1	2.69	6.88	7.63	8.25	8.25	7.50	.38	1	7.38	8	2.50	5.50	2.31	2.69	2.63	6.56	6.75
8	1.38 STD	4.25	3.25	3.75	1	1.31	.69	.81	1.38	7.57	NA	1.13	1.38	4.50	9.88	NA	12.50	11.25	11.25	.38	1.63	8.25	NA	2.63	6	2.31	2.81	2.75	7.31	6.75
	1.75 OR	4.25	3.25	3.75	1	1.31	.69	.81	1.38	7.57	NA	1.13	1.38	4.50	9.88	NA	12.50	11.25	11.25	.50	1.88	8.50	NA	2.88	6.25	5.56	3.06	3	7.56	7
10	1.75 STD	-	4.13	-	-	-	-	-	9.40	NA	1.50	-	5.50	-	NA	-	-	-	-	.50	1.88	10.38	NA	-	-	-	3.13	3.06	8.94	8.25
	2 OR	-	4.13	-	-	-	-	-	9.40	NA	1.50	-	5.50	-	NA	-	-	-	-	.38	2	10.50	NA	-	-	-	3.25	3.19	9.06	8.38
12	2 STD	-	4.63	-	-	-	-	-	11.1	NA	1.50	-	7.25	-	NA	-	-	-	-	.38	2	11.13	NA	-	-	-	3.25	3.19	9.56	8.88
	2.50 OR	-	4.63	-	-	-	-	-	11.1	NA	1.50	-	7.25	-	NA	-	-	-	-	.50	2.25	11.38	NA	-	-	-	3.50	3.44	9.81	9.13

## How To Order

### HD-800 x 10-FB-DR

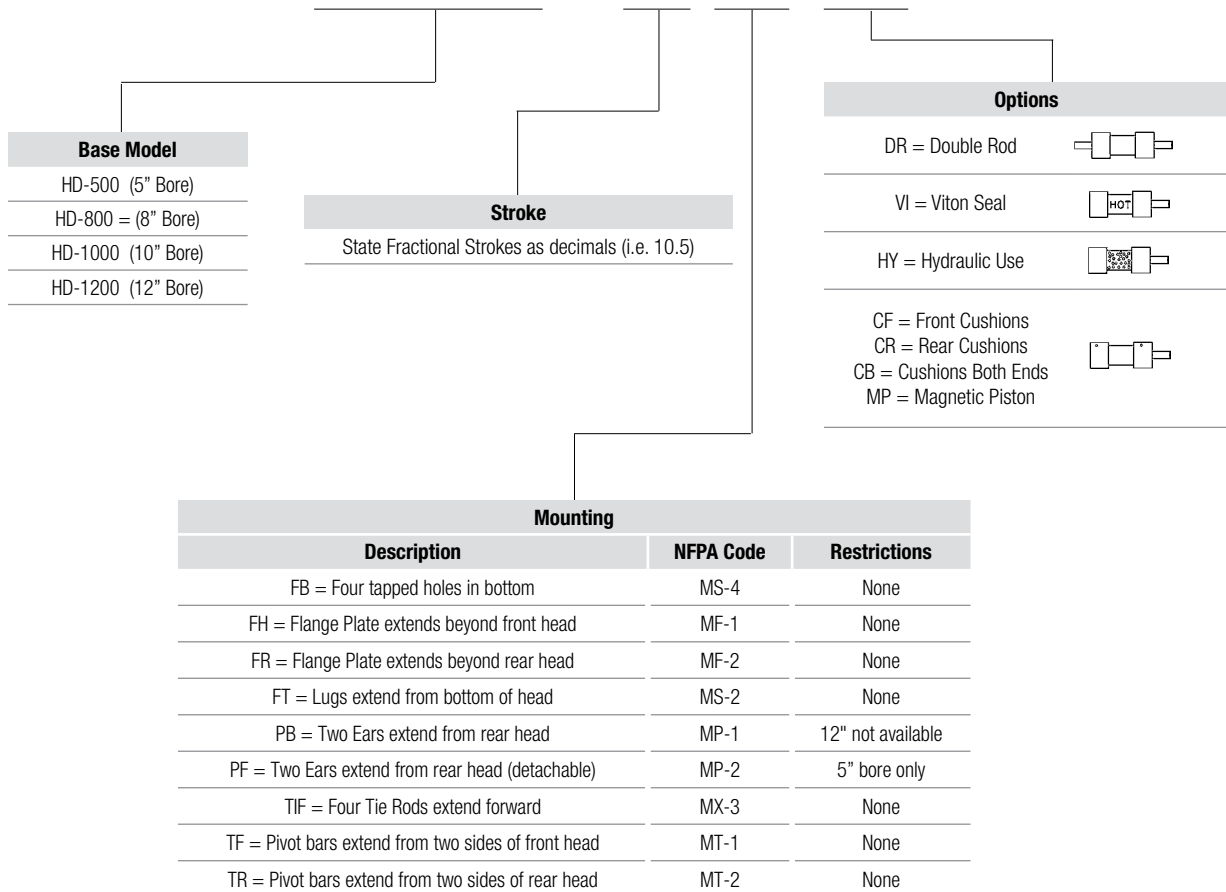

# Product Features

## Features & Benefits

### Low Cost Mounting

The flush bottom cylinder mounts directly onto a base plate with only two bolts... no need for mounting brackets or other hardware. The pivot bracket is built-in for easy pivoting at the inlet axis. The bracket pivots within the cylinder length to save space and to eliminate one entire bracket that would be needed to mount other cylinders.

Because Centaur's trunnions serve both as mounts and as assembly elements, they cost less than any other trunnion mount on the market.

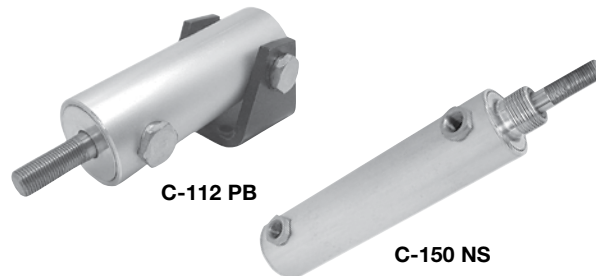

### Economical & Repairable

Bimba Centaur cylinders are built to match tie-rod performance, but are up to 45% less expensive and offer lubrication-free service. Centaur cylinders are not permanently crimped like most other round cylinders, so they can be disassembled for maintenance.

### Teflon Seals Create Smooth Breakaway

Centaur's unique Teflon® piston seal eliminates the forward lurch that occurs when rubber seals breakaway from the cylinder tube surface. Rod motion remains smooth throughout the stroke.

### Non-Lube

During the cylinder break-in period, molecules from the unique graphite-filled Teflon® piston seal became embedded in the pores of the hard coated aluminum cylinder tube. This forms a long-lasting, super-smooth, self-lubricated surface.

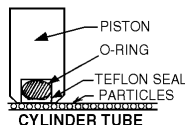

### Built-In Bumpers Absorb Impact

Rubber bumpers are built into each cylinder head to eliminate the metallic "clank" that occurs at stroke completion.

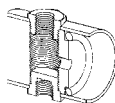

### Self Aligning Rod Couplers

Rod couplers simplify cylinder alignment problems by compensating for 2° angular error and 1/16" lateral misalignment on both extension and retraction strokes.



See page 62 for complete listing of Bimba's self-aligning rod couplers.

Model	C-112	C-150	C-200	C-250	C-300
Rod Coupler	DMA-312	DMA-500	DMA-625	DMA-750	DMA-1000

### Proximity Switches

Solid State and Reed switches can sense rod position anywhere within the stroke. A stainless steel clamp facilitates mounting at any location along the cylinder tube. Switches may be used singly or in multiples and positioned at any point around the cylinder tube. The cylinder must have a magnetic piston. For technical information, see page 71.



Model	C-112	C-150	C-200	C-250	C-300
Sinking	N/A	CS-6100N-150	CS-6100N-200	CS-6100N-250	CS-6100N-300
Sourcing	N/A	CS-6100P-150	CS-6100P-200	CS-6100P-250	CS-6100P-300
Reed	N/A	CS-6100R-150	CS-6100R-200	CS-6100R-250	CS-6100R-300

## Technical Data

### Operating Parameters

Technical Specifications	
Pressure:	150 PSI Air
Bore Sizes:	1-1/8", 1-1/2", 2", 2-1/2" and 3"
Body:	Hard Coated Aluminum
Rod Bearing:	Oil Impregnated Porous Bronze
Temperature Range:	-40° F to 250° F (-40° C to 121° C) (to 400° F [204° C] on request)

## Product Information

### Dimensions

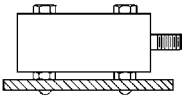
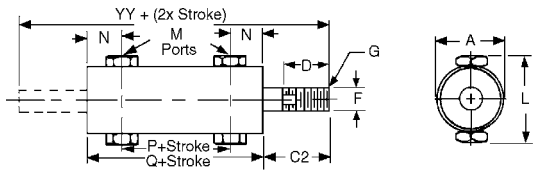

Flush Bottom (FB)

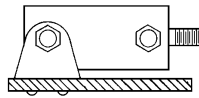

Pivot Bracket (PB)

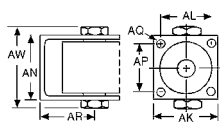
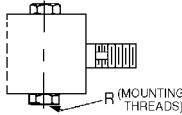

### Hall Effect

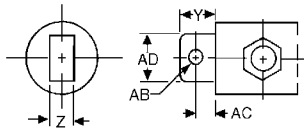
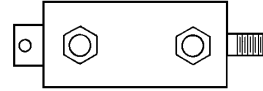
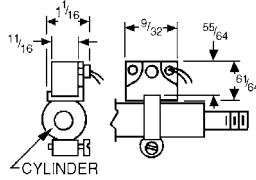

Pivot Extended (PE)  
1-1/8", 1-1/2" & 2" bores only

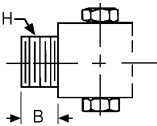
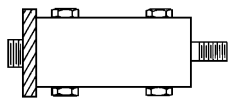

Flush Rear (FR)  
1-1/8" bore only

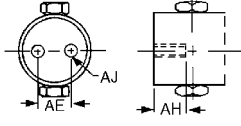
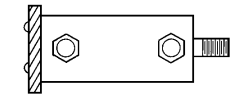

Flush Rear (FR)  
1-1/2", 2", 2-1/2" & 3" bores only

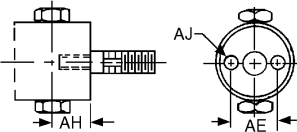
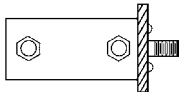

Flush Front (FF)  
1-1/2", 2", 2-1/2" & 3" bores only

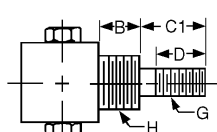
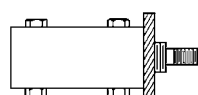

Threaded Nose (NS)  
Std. on all 1-1/8" bore mounts  
1-1/8", 1-1/2" & 2" bores only

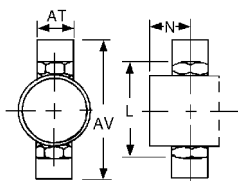
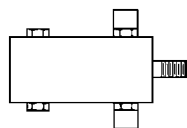

Trunnion Rear (TR)

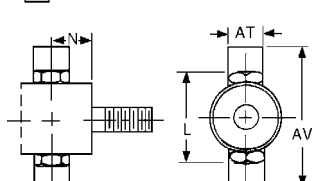

Trunnion Front (TF)

	Bore Sizes				
	1-1/8"	1-1/2"	2"	2-1/2"	3"
<b>A</b>	1-3/8	1-3/4	2-1/4	2-3/4	3-1/4
<b>B</b>	5/8	13/16	13/16	-	-
<b>C1</b>	5/8	1-5/8	1-7/8	-	-
<b>C2</b>	-	1-7/16	1-11/16	1-3/4	2-1/16
<b>D</b>	1/2	1-1/4	1-1/2	1-1/2	1-3/4
<b>F</b>	5/16	1/2	5/8	3/4	1
<b>G</b>	5/16-24	1/2-20	5/8-18	3/4-16	1-14
<b>H</b>	3/4-16	1-14	1 1/4-12	-	-
<b>L</b>	2-3/32	2-1/8	2-5/8	3-1/8	3-5/8
<b>M</b>	1/8 NPT*	1/4 NPSF	1/4 NPSF	1/4 NPSF	1/4 NPSF
<b>N</b>	7/16	51/64	51/64	51/64	51/64
<b>P+Stroke</b>	1-21/64	1-27/32	1-59/64	2-3/64	2-11/64
<b>Q+Stroke</b>	2-13/64	3-7/16	3-1/2	3-5/8	3-3/4
<b>R</b>	10-32	3/8-24	3/8-24	3/8-24	3/8-24
<b>Y</b>	5/8	15/16	1-1/8	-	-
<b>Z</b>	3/8	11/16	3/4	-	-
<b>AB</b>	1/4	3/8	1/2	-	-
<b>AC</b>	3/8	9/16	5/8	-	-
<b>AD</b>	5/8	1	1-1/4	-	-
<b>AE</b>	-	1-1/8	1-1/2	1-3/4	2
<b>AH</b>	-	1/2	5/8	3/4	7/8
<b>AJ</b>	-	1/4-28	5/16-24	3/8-24	1/2-20
<b>AK</b>	1-5/8	2-1/4	2-1/4	2-7/8	3-1/8
<b>AL</b>	1-1/4	1-5/8	1-5/8	2-1/8	2-3/8
<b>AN</b>	1-3/4	2-13/32	2-29/32	3-13/32	3-29/32
<b>AP</b>	1	1-1/8	1-5/8	2-1/8	2-5/8
<b>AQ</b>	13/64	9/32	9/32	9/32	9/32
<b>AR</b>	31/32	1-9/16	1-13/16	1-15/16	2-5/16
<b>AT</b>	.418	.731	.731	.731	.731
<b>AV</b>	2-5/32	3-5/8	4-1/8	4-5/8	5-1/8
<b>AW</b>	2-17/64	2-13/16	3-5/16	3-13/16	4-5/16
<b>YY +(2 X STK)</b>	4-23/32	6-5/16	6-7/8	7-1/8	7-1/8

\* 1-1/8 bore model with trunnion mounts has 1/4-28 ports.

# How To Order

## How To Accessorize

Rod Clevis w/Pin (CEC)

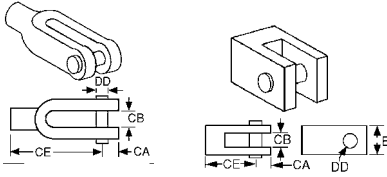

1-1/8" & 1-1/2" bores

2" & 3" bores

**NOTE:** For DMC-4, refer to pages 60.

Nose Nuts (CN)

1-1/8", 1-1/2" & 2" bores only

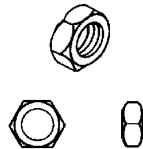

### Rod Clevis Accessory Dimensions

Bore	E	CA	CB	CE	DD
1-1/8"	-	19/64	11/32	13/16	5/16
1-1/2"	-	15/32	9/16	1-13/16	1/2
2"	1-1/4	7/16	5/8	2-1/16	1/2
2-1/2"	1-1/2	3/4	1-1/4	2-3/8	3/4
3"	1-1/4	7/16	5/8	2-1/16	1/2

### Model Numbers

Bore Sizes Accessory	1-1/8"	1-1/2"	2"	2-1/2"	3"
Rod Clevis, Pin	CEC-112	CEC-150	CEC-200	DMC-4	CEC-300
Nose Nut	CN-112	CN-150	CN-200	-	-

## How To Order

### Air Reservoirs

Two Centaur rear heads and a tube form an economical air tank. Consult factory for more information. Simply add AR to model.

### Ordering Information

When ordering Centaur cylinders, list the model number, stroke length and mounting option(s) required. Please consult the factory for stainless steel rods, air reservoirs or any special cylinder need.

## C-112 x 4-NS

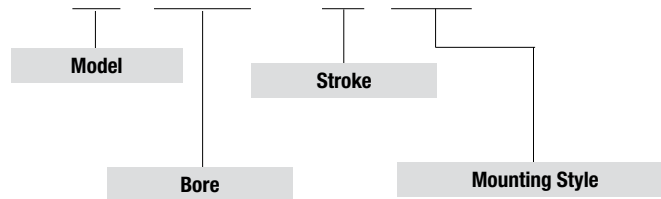

Bore Model	1-1/8" C-112	1-1/2" C-150	2" C-200	2-1/2" C-250	3" C-300
Nose Mount (NS)	•	•	•	NA	NA
Flush Bottom (FB)	•	•	•	•	•
Flush Front (FF)	NA	•	•	•	•
Flush Rear (FR)	•	•	•	•	•
Pivot Bracket (PB)	•	•	•	•	•
Pivot Extended (PE)	•	•	•	NA	NA
Trunnion Front (TF)	•	•	•	•	•
Trunnion Rear (TR)	•	•	•	•	•
Other Options:	•	•	•	•	•
Double Rod (DR)	Δ	•	•	•	•
Dupont Viton Seals (VI)	•	•	•	•	•
Magnetic Piston (MP)	NA	•	•	•	•
Air Reservoir (AR)	•	•	•	•	•

Δ Nose (NS) mounts standard on both ends of 1 1/8" bore model with double rod.

## Features & Benefits

### Installation and Operation

Proximity switches provide contactless switching capabilities and allow you to sense cylinder rod position practically anywhere within the stroke. Switches are easily mounted on any point along the cylinder body. The switch will provide an electrical signal when subjected to the magnetic field created by a cylinder piston that is specially fitted with a captivated magnet.



Switch	Compatible with
CS-6100	Centaur Round Body Cylinders
CS-6200	DM1 and HD1 Tie Rod Cylinders
CS-7500	DM2 Extruded Body Cylinders

## Connection Diagrams

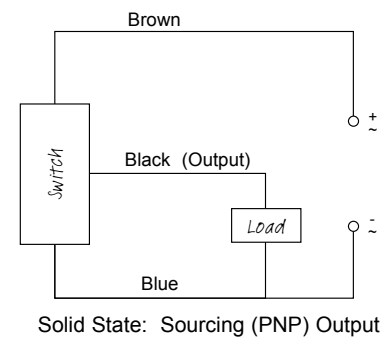
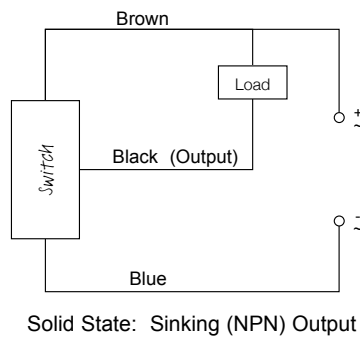
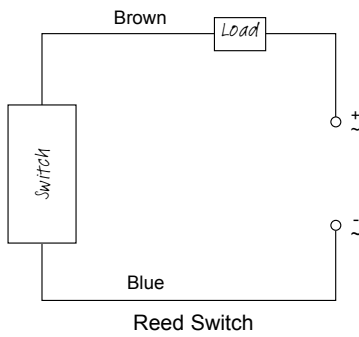

## How To Order

Model Number	Switch Type	Switching Logic	Operating Voltage	Switching Current	Switching Power	Switching Drop	Magnetic Sensitivity
CS-7500R	Reed Switch	Normally Open SPST	5~240 VDC/VAC 50/60Hz	1 Amp. Max.	30 Watts Max.	3.5 V Max.	85 Gauss
CS-6100R							
CS-6200R							
CS-7500P*	Solid State (MR) Sensor	Normally Open	5~28 VDC	1 Amp. Max.	24 Watts Max.	1.5 V Max. (0.5 Amp)	85 Gauss
CS-6100P*							
CS-6200P*							
CS-7500N*							
CS-6100N*							
CS-6200N*							

\* P = Sourcing, N = Sinking

3m cable leads on switches

# Product Features

## Features & Benefits

### Full Power in Half the Space

Space Saver cylinders provide the power and stroke of standard cylinders in less than half the space. They are ideally suited for use in machinery where space and weight are at a premium. Best of all, Space Saver cylinders cost up to 50% less than standard models.

### Built to Last

- > Oil impregnated sintered bronze rod bearing and hard chrome plated piston rod work together to prolong cylinder life.
- > Hard coated cylinder bore eliminates cylinder wall scoring.



SS-250



SS-300

### Offers A Wide Range Of Power

Bore	3/4"	1-1/8"	1-1/2"	2"	2-1/2"	3"	4"
Force @ 100 PSI (lbs)	44	100	177	314	491	707	1257

NOTE: Pull force is approximately 10% less.

### Perfect for Tooling

Space Saver cylinders are ideal for use on drill fixtures and other automated tooling to provide compact, lightweight holding power.

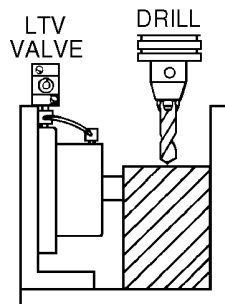

### Valving

Efficient 4-way LTV valves, shown on pages 20-21, are perfect as actuators of Space Saver cylinders. Valve hookup is made easy because the top cylinder port reindexes to any position.

## Technical Data

Specifications	
Pressure:	0-150 PSI, Air only
Temperature:	-40° F to 250° F (-40° C to 121° C) (to 400° F [204° C] with Viton)
Lubrication:	Petroleum base oil
Filtration:	40 Micron minimum
Seals:	Buna-N



## Product Information

### Dimensions

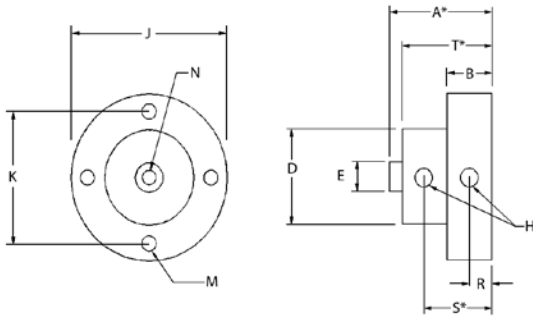

**NOTE:** 3/4" - 2" Bore Models have two (2) Mounting Holes. See Dimension M.

Bore	3/4"	1-1/8"	1-1/2"	2"	2-1/2"	3"	4"
A*	0.77	0.78	0.91	1.06	1.08	1.37	1.52
B	0.50	0.50	0.50	0.56	0.56	0.75	0.75
D	1.00	1.38	1.75	2.25	2.75	3.25	4.25
E	0.31	0.50	0.50	0.63	0.63	0.75	0.75
H	#10-32	#10-32	#10-32	1/8 NPT	1/8 NPT	1/8 NPT	1/8 NPT
J	1.74	2.12	2.49	3.11	3.74	4.24	5.22
K	1.41	1.78	2.16	2.72	3.25	3.78	4.78
M	0.19	0.19	0.19	0.19	0.27	0.27	0.27
N	#10-32 X .25	5/16-24 X .38	5/16-24 X .38	3/8-24 X .38	3/8-24 X .38	1/2-20 X .50	1/2-20 X .50
R	0.16	0.16	0.16	0.31	0.31	0.33	0.33
S*	0.38	0.38	0.51	0.69	0.68	0.91	1.04
T*	0.76	0.77	0.90	1.05	1.06	1.36	1.50

\* Plus Stroke

**NOTE:** To obtain a 1/8" or 3/16" stroke on 3/4" or 1-1/8" bore models, a 1/4" stroke cylinder is used and spacers are added.

### Stroke Availability

Model	Stroke Lengths												
	Bore	1/8	3/16	1/4	3/8	1/2	5/8	3/4	1	1-1/2	2	2-1/2	3
SS-075	3/4"	X*	-	X*	X	X	X	X	X	X	X	-	-
SS-112	1-1/8"	X*	X*	X*	-	X	-	X	X	X	X	X	X
SS-150	1-1/2"	X*	-	X	-	X	-	X	X	X	X	X	X
SS-200	2"	X	-	X	-	X	-	X	X	X	X	X	X
22-250	2-1/2"	X	-	X	-	X	-	X	X	X	X	X	X
SS-300	3"	X	-	X	-	X	-	X	X	X	X	X	X
SS-400	4"	X	-	X	-	X	-	X	X	X	X	X	X

\* Includes special fitting

**NOTE:** To obtain a 1/8" or 3/16" stroke on 3/4" on 1-1/8" bore models, a 1/4" stroke cylinder is used and spacers are added.

Non-standard strokes subject to special machining charge.

### Mounting Options

Uniform base thickness makes mounting easy regardless of stroke.

### How To Order

When ordering, specify model number, stroke length, and Viton seal option if required

**Example:** SS-150 X 0.25 - FB-VI

# Product Features

## Features & Benefits

### MA Series – Mini Adjustable Location Cylinders

These threaded body cylinders install quickly and easily without special mounting devices. Either drill a hole, insert your cylinder, and position with the pair of jam nuts or tap a hole and lock into position with a single jam nut. The MA-Series cylinders are electroless nickel plated for excellent corrosion resistance and a gleaming appearance.

**Non-rotating:** This option is available on 3/8" and 1/2" bore, single-acting, spring return cylinders.

#### Stroke Length Availability

The MA-250 (1/4" Bore) single acting is only available in 1/4" stroke lengths. The MA-250 double acting is available in 1/4", 1/2" and 1" stroke lengths. The MA-375 (3/8" Bore) and MA-500 (1/2" Bore) single acting is available in 1/4" and 1/2"; the double acting version is available in 1/4", 1/2", 1", 1 1/2" and 2" stroke lengths. By adding a spacer, all models are also available in fractional stroke lengths for no additional charge. (Dimensionally the cylinder will be the same as the next closest size up.) If other strokes are required, contact Bimba to quote a custom stroke length.

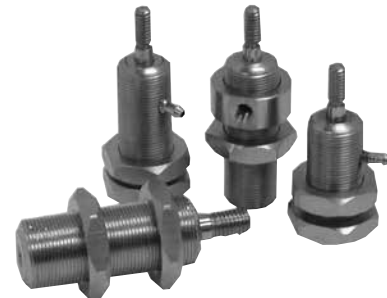

MA Series

### MF Series – Mini Flat Mount Cylinders

Bimba's MF Series are miniature, rectangular flat mount cylinders. MF cylinders are available in both single and double-acting models with strokes up to 2".

All ports are tapped 10-32 except the front ports of 1/4" bore models, which have a 6-32 barb fitting. The standard location for the rear extend port is denoted by location "N" on the dimensional drawing. As an option, a rear side port can be ordered special. Contact Bimba for details.

#### Mini Cylinders Mount Anywhere!

Bimba's line of miniature air cylinders offers users a wide range of low-profile linear actuators. These versatile cylinders are available in both single-acting and double-acting models. They are ideal actuators in any application where space is limited.

#### Stroke Length Availability

This series is available in 1/4" and 1/2" standard stroke lengths.\* By adding a spacer, all models are also available in fractional stroke lengths for no additional charge. (Dimensionally the cylinder will be the same as the next closest size up.) If other strokes are required, contact Bimba to quote a custom stroke length.

**\*NOTE:** The MF-250 (1/4" bore), Single Acting (SR or SE) is only available in 1/4" standard stroke length.

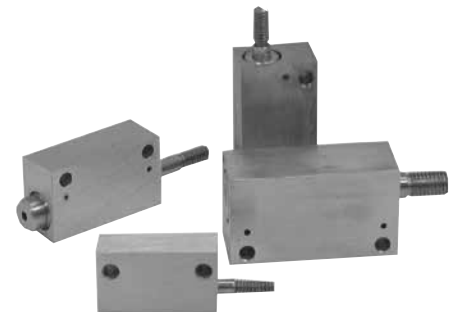

MF Series

## Technical Data

General Specifications	
Seals:	Buna-N (Viton Optional)
Temperature:	Buna-N seals = 0° F to 220° F (-18° C to 104° C)
Viton Seals:	0° F to 400° F
Operating Pressure:	to 125 PSI
Piston Rods:	Stainless Steel
Rod Bearings:	660 Bronze
Lubrication:	Recommended - non detergent petroleum based
Filtration:	40 Micron

## Product Information

### Dimensions – MA Series

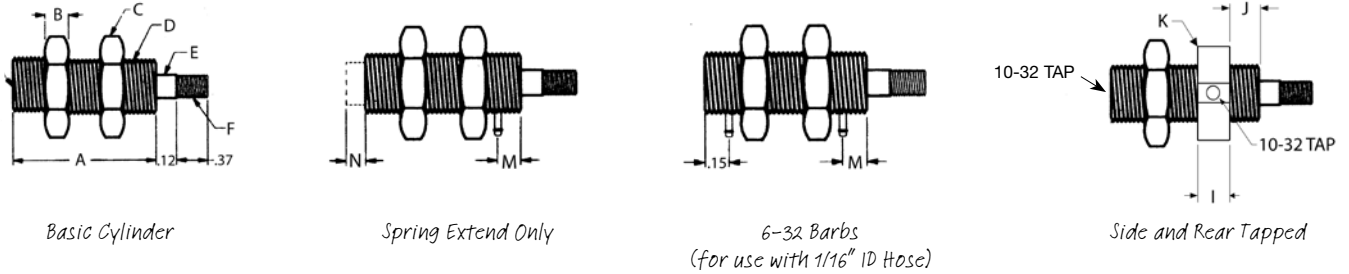

Bore	A=Stroke+	B	C	D	E	F	I	J	K	M	N
1/4"	0.81	.15	.62	3/8-32	.14	6-32	.31	.06	.62	.20	.10
3/8"	1.00	.18	.75	1/2-32	.17	8-32	.31	.21	.75	.37	.18
1/2"	1.06	.18	.87	5/8-32	.25	1/4-28	.31	.21	.87	.37	-

### Dimensions – MF Series

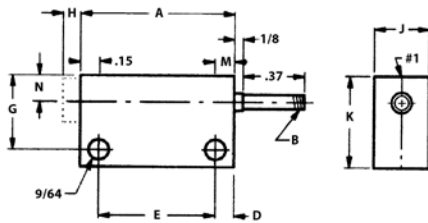

Figure 1: For strokes up to 1/2"

#1: Indicates port locations. The H dimension is for spring extend cylinders only.

When nominal forces are adequate, this table may be helpful.

Typical Spring Forces			
Spring Return Stroke	Ounces	Spring Extend Stroke	Ounces
250 - 1/4"	14-18	250 - 1/4"	25-29
375 - 1/4"	22-26	375 - 1/4"	30-34
375 - 1/2"	22-26	375 - 1/2"	54-58
500 - 1/4"	42-46	500 - 1/4"	62-66
500 - 1/2"	51-55	500 - 1/2"	78-80

Bore	Stroke	A	B	D	E	G	H	I	J	K	M	N	O	Front Port	Rear Port
1/4"	1/4"	1.06	6-32	.12	0.81	7/16"	.10	.31	3/8"	5/8"	.20	.18	5/16"	6-32	10-32
	1/2"	1.31	6-32	.12	1.06	7/16"	-	.31	3/8"	5/8"	.20	.18	5/16"	Barb	Tap
3/8"	1/4"	1.25	8-32	.15	0.93	5/8"	.18	.37	1/2"	3/4"	.37	.25	7/16"	10-32	10-32
	1/2"	1.50	8-32	.15	1.18	5/8"	.18	.37	1/2"	3/4"	.37	.25	7/16"	Tap	Tap
1/2"	1/4"	1.31	1/4-28	.15	1.00	3/4"	-	.37	5/8"	7/8"	.37	.31	9/16"	10-32	10-32
	1/2"	1.56	1/4-28	.15	1.25	3/4"	-	.37	5/8"	7/8"	.37	.31	9/16"	Tap	Tap

### Dimensions For Cylinders With Strokes Over 1/2"

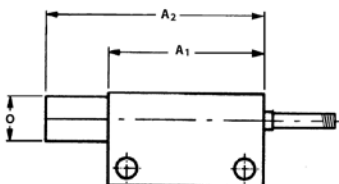

Figure 2: For strokes over 1/2"

Bore	A <sub>1</sub>	A <sub>2</sub>
1/4"	1.06	0.81 + Stroke
3/8"	1.25	1.00 + Stroke
1/2"	1.31	1.06 + Stroke

# How To Accessorize

## Accessories

Description	Model Number
Fitting: 10-32 to 1/16" ID Hose	PMHF
Fitting: 6-32 Barb to 1/16" ID Hose	PMBF
Hex Nut for 1/4" Bore Cylinder	PMH-250
Hex Nut for 3/8" Bore Cylinder	PMH-375
Hex Nut for 1/2" Bore Cylinder	PMH-500
1/16" ID Tube Clear Polyurethane (50 ft.)	11NAT

## Mounting Blocks



PMB-250

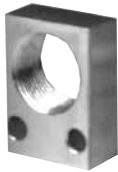

PMB-375



PMB-500

Bore	PMB 250 1/4"	PMB 375 3/8"	PMB 500 1/2"
Width	0.503	0.626	0.75
Height	0.879	0.876	0.94
Depth	0.314	0.314	0.38
Hole (2)	0.14	0.139	0.136

## How To Order

### MA-500 x 1.00-DA-R B (\*\*\*)

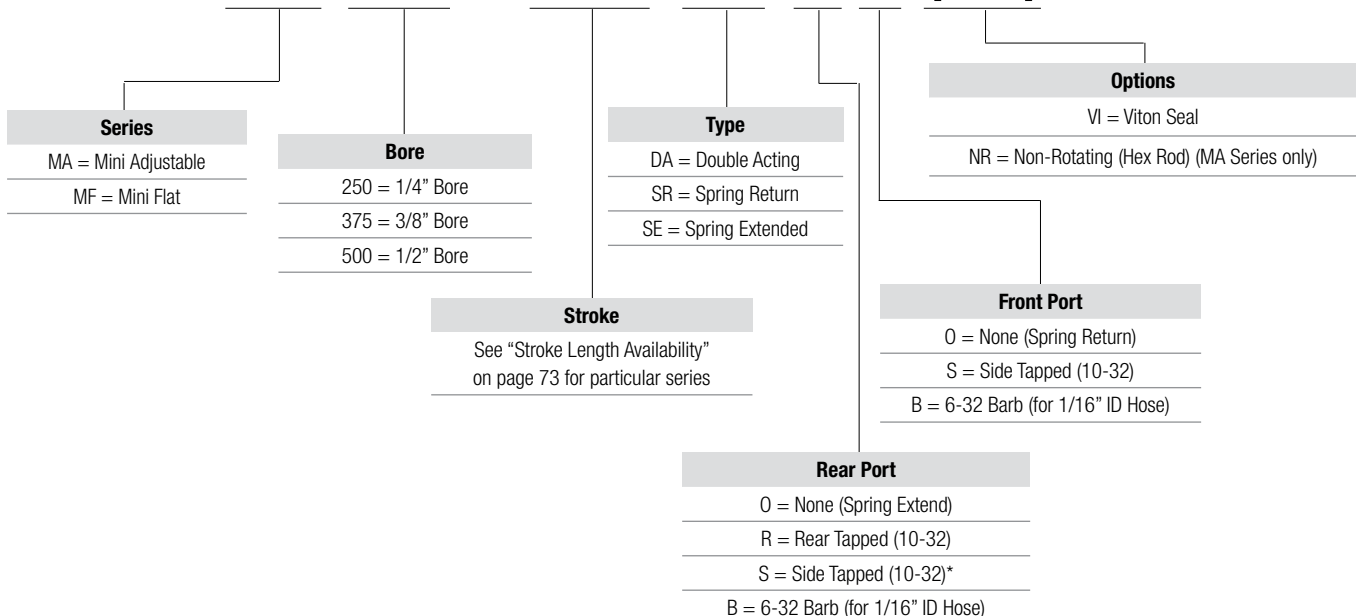

\* Special Order (non-stock; contact factory)

## Features & Benefits

Economical single-acting air clamps provide gripping power on the out stroke and spring retraction. They are ideal for use in drill fixtures and for bending, swaging, forming, crimping, and pressing operations. Because 3-way valves may be used, hook-ups are quick and easy.

### Adjustable Stroke Models

H0X01, H1X12, V0X01, and V1X12 models are supplied with an adjustable front head so that the user may adjust the length of the stroke by as much as one inch.



VOX01



H-1



V-1

## Technical Data

Specifications	
Pressure:	Air to 150 PSI
Temperature:	-40° F to 250° F (-40° C to 121° C)
Rod Material:	Nitrotec plated steel on 1" bore models, ground and polished on all others.
Seals:	Custom molded one-piece neoprene cups
Body & Cover:	Aluminum on adjustable models, cast aluminum on all other models. Cast iron on H-12 and H-283.
Lubrication:	Petroleum base oil
Filtration:	40 Micron minimum

# How To Specify

## Product Information

### Dimensions

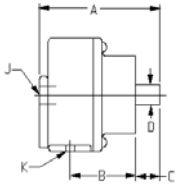
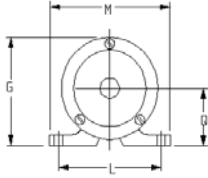

Single Side Lug

Dimension	H-1	HOX-01	H1X-12	H-41	H-71
A	2-25/32	4	5	4-7/8	5-5/16
B	1-11/32	Var.		2-1/4	2-3/4
C	5/8	Var.		1-1/2	1-7/16
D	5/16	5/16		1/2	3/4
G	1-1/4	1-9/16		3-1/16	3-23/32
J	1/8 NPTF	1/8 NPTF		1/8 NPTF	1/4 NPTF
K	3/16	.200		1/2 Slot	21/64
L	1-5/8	1-5/8		3 1/2	4-5/8
M	2	2-1/8		4-7/16	5-3/8
Q	5/8	13/16		1-9/16	1-15/16

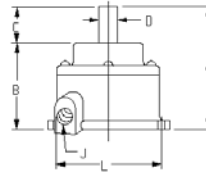
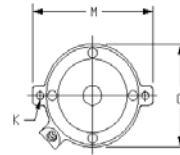

Base Mount

Dimension	V-1	VOX-01	V1X-12	V-41
A	2-5/8	3-13/16	4-13/16	4-5/8
B	1-15/16	Var.		3-3/16
C	11/16	Var.		1-7/16
D	5/16	5/16		1/2
G	1-9/16	1-3/4		3
J	1/8 NPTF	1/8 NPTF		1/8 NPTF
K	3/16	.200		.257
L	1-11/16	1-5/8		3-3/4
M	2-1/8	2		4-1/4

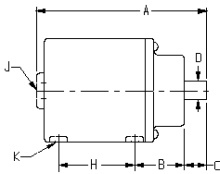
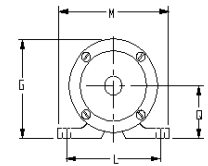

Double Side Lug

Dimension	H-72	H-73	H-12	H-283
A	6-5/16	7-5/16	7	9
B	2-3/16	2-3/16	2-9/16	3-1/2
C	1-7/16	1-7/16	1-7/16	1-7/16
D	3/4	3/4	3/4	1-1/4
G	3-11/16	3-11/16	5-1/16	7-1/16
H	2-1/16	3-1/16	2-5/16	7-1/16
J	1/4 NPTF	1/4 NPTF	3/8 NPTF	1/2 NPTF
K	21/64	21/64	1/2 Slot	1/2-13
L	4-5/8	4-5/8	5-1/2	5-5/8
M	5-1/4	5-1/4	7	6-3/4
Q	1-7/8	1-7/8	2-9/16	3-9/16

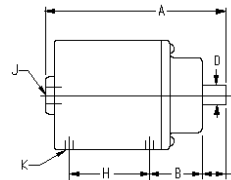
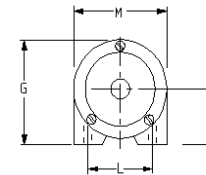

Bottom Flush

Dimension	H-42	H-122
A	5-13/16	7-9/16
B	2-5/8	2-5/8
C	1-7/16	1-7/16
D	1/2	3/4
G	3-1/16	4-31/32
H	-	2-1/2
J	1/8 NPTF	3/8 NPTF
K	1/4-20	5/16-18
L	2-1/4	2-1/4
M	3	4-13/16
Q	1-9/16	2-9/16

## How To Order

Models	Return‡	Bore(″)	Stroke(″)	Output*
H-1 & V-1	4	1	11/16	68
H0X01 & V0X01	5	1	0 to 1	62
H1X12 & V1X12	5	1	1 to 2	61
H-41 & V-41	9	2-1/4	1	361
H-42	10	2-1/4	2	353
H-71	18	3	1	682
H-72	13	3	2	675
H-73	14	3	3	679
H-12	39	4	2	1206
H-122	27	4	2-5/8	1204
H-283	40	6	3	2763

‡ Maximum weight in pounds that spring will return.

\* Force in pounds at 100 PSI input pressure with maximum spring resistance.





# Specialty Valves

Bimba's Specialty Valves help complete pneumatic circuits with specific requirements. By utilizing unusual body types, flow rates, and actuation profiles, our Specialty Valves fill a need in your challenging pneumatic applications!



# Contents

---

83	Lockout & Easy-Glide Ball Handle Valves	89	Pneumatic Stroke Completion Sensors
	83 – Technical Data		89 – Features & Benefits
	83 – Dimensions		89 – How It Works
	83 – How To Order		89 – How To Order

---

84	MHL Series Easy-Glide Ball Handle Valves	90	Air To Electric Switches
	84 – Technical Data		90 – Features & Benefits
	84 – Dimensions		90 – Dimensions
	84 – How To Order		90 – How To Order

---

85	General Purpose Mini Solenoid Valves	91	Dash/Panel Mount Control Valves
	85 – Technical Data		91 – Technical Data
	85 – Dimensions		91 – How It Works
	85 – How To Order		91 – Dimensions
			92 – How To Order

---

86	Binary Valves	93	Dyla-Trol® Flow Control Valves
	86 – Technical Data		93 – Features & Benefits
	86 – How It Works		93 – Technical Data
	86 – Dimensions		94 – How To Order
	86 – How To Order		

---

87	Air Timers Delay Signal	95	Two-Hand Control Valves
	87 – Technical Data		95 – Features & Benefits
	87 – How It Works		95 – How It Works
	87 – How To Order		96 – How To Order

---

88	Pneumatic Impulse Relay Valves		
	88 – Technical Data		
	88 – How It Works		
	88 – How To Order		

---

## Features & Benefits

### Slide/Lockout Valve

Bimba's Slide/Lockout Valves (SLV) are designed to comply with OSHA Standard Rule 29 CFR1910.147. SLVs exhaust downstream air to atmosphere when the valve is in the closed position. This prohibits the unexpected cycling of equipment due to stored energy in the air line. These valves can only be locked in the closed position, rendering any downstream machinery or equipment completely inoperable. The aluminum sleeve is anodized bright gold for easy identification.

### Put a Lock on Plant Accidents

In the open position, air flows freely through the valve to downstream equipment or tool.

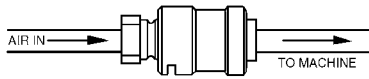

In the closed position, air from compressor side is restricted while exhaust air bleeds to atmosphere, rendering downstream equipment inoperable. Lockout is only possible in the closed position.

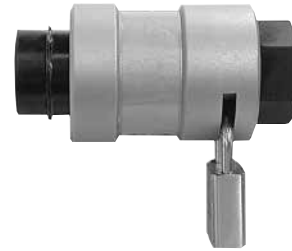
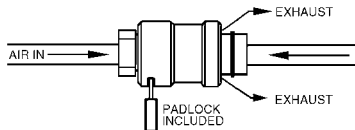

SLV-37

### "Gang Lock" Option

SLVs may be ordered with a gang lock adapter rather than the standard Bimba padlock. The adapter permits the use of one or multiple standard padlocks. To order, add a "G" to the model (i.e. SLVG-50).

### OSHA Rule 29 CFR1910.147\*

To protect employees from the unexpected energization or release of stored energy during repair, maintenance and associated activities, this standard requires potentially hazardous energy sources for certain equipment to be disabled and either be locked or labeled with a warning tag to prevent unauthorized start-up of these machines or equipment.

\*Copies of the actual OSHA standard may be obtained from the U.S. Department of Labor, Occupational Safety and Health Administration, Office of Publications, Room N3101, Washington, D.C. 20210.

## Technical Data

Specifications	
Temperature Range:	-50° F to 180° F (-46° C to 82° C)
Pressure Range:	0 to 150 PSI
Material:	
Body:	Black Anodized Aluminum
Sleeve:	Gold Anodized Aluminum
Retaining Ring:	Steel
O-Rings:	Buna-N
Lock:	Solid Brass (Steel Shackle)

**Warning:** SLVs are not to be used for lockout of hydraulic fluid.

## How To Specify

### Dimensions

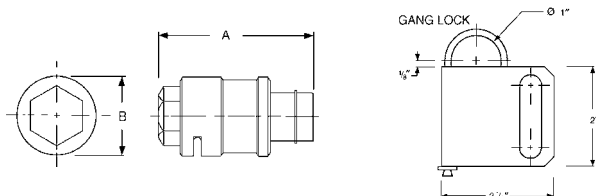

## How To Order

Model	Model (with Gang Lock)	Port Size	C <sub>v</sub>	A (in.)	B (in.)
SLV-25	SLVG-25	1/4" NPT	0.94	2-9/16"	1-1/4"
SLV-37	SLVG-37	3/8" NPT	2.00	2-15/16"	1-7/16"
SLV-50	SLVG-50	1/2" NPT	3.18	3-11/32"	1-5/8"

**NOTE:** Use part #LCK100 to order replacement lock and key set.  
Use part #2028002 to order replacement gang lock.

# Product Features

## Features & Benefits

### Low Friction Motion

MHL valves provide either 3-way pilot control (MHL-3) or 4-way directional control (MHL-4). To operate MHL valves, simply move the ball handle across the slot on the valve body. The handle rotates a precision-lapped disc to control the directional flow of air. The hardcoat anodized aluminum disc allows virtually effortless handle motion. The handle will hold in any position. Air exhausts through the disc and out to atmosphere.

Base mount holes make mounting and removal quick and easy. Further, MHL valves are easy to disassemble. By simply removing the ball handle and snap ring, any part worn by use can be found and replaced.



MHL-3/MHL-4

## Technical Data

### General Specifications

Flow:	0.14 C <sub>v</sub>
Ports:	1/8" NPT
Temperature Range:	-40° F to 250° F (-40° C to 121° C)
Lubrication:	SAE 10
Pressure Range:	0 to 150 PSI (Air Only)
Seals:	Buna-N

## How To Specify

### Dimensions

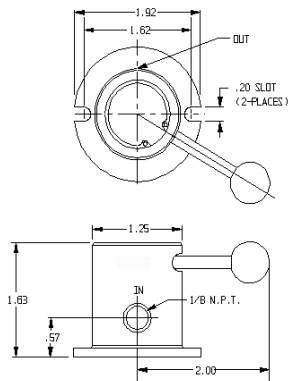

## Features & Benefits

### Mini Solenoid Valves

Dyna-Coil valves are used when you need to convert an electrical signal into a flow of air. 2-way models allow air to flow through the valve when energized. 3-way models allow air to flow through the valve when energized and exhaust when de-energized.

Normally closed means inlet air is blocked until the valve is energized. Normally open means inlet air flows through the valve and is blocked when energized.



MB25-3USC

## Technical Data

General Specifications	
Media:	Air (Max. Temperature 185° F / 85° C)
Pressure:	Vacuum to 120 PSI
Orifice:	0.038"
Conduit:	1/2" NPS
Response:	20-30 ms
Base:	Aluminum
Mounting Holes (2):	8-32 UNC-2B Threads
Lubrication:	None Required
Filtration:	40 Micron Minimum

## How To Specify

### Dimensions

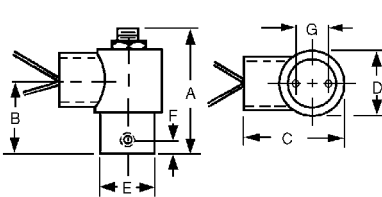

1/8" and 1/4" CSC Models

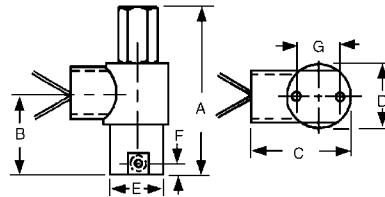

1/8" and 1/4" USC Models

## How To Order

Model	Ports	Style	Exhaust	Voltage	Cv (In)	Cv (Exh)	A	B	C	D	E	F	G
MB12-2CSC	1/8" NPT	2-Way NC	None	24 VAC, 120 VAC, 240 VAC, 12 VDC, 24 VDC	.035	-	2-5/16	1-3/8	1-27/32	1-3/16	1	9/32	.738
MB25-2CSC	1/4" NPT	2-Way NC	None	24 VAC, 120 VAC, 240 VAC, 12 VDC, 24 VDC	.035	-	2-3/8	1-1/2	1-27/32	1-3/16	1-3/16	5/16	29/32
MB12-3CSC	1/8" NPT	3-Way NC	Free to Atmos.	24 VAC, 120 VAC, 240 VAC, 12 VDC, 24 VDC	.035	.050	2-5/16	1-3/8	1-27/32	1-3/16	1	9/32	.738
MB12-3USC*	1/8" NPT	3-Way NC, NO	Piped	24 VAC, 120 VAC, 240 VAC, 12 VDC, 24 VDC	.035	.050	2-23/32	1-3/8	1-27/32	1-3/16	1	9/32	.738
MB25-3CSC	1/4" NPT	3-Way NC	Free to Atmos.	24 VAC, 120 VAC, 240 VAC, 12 VDC, 24 VDC	.035	.050	2-3/8	1-1/2	1-27/32	1-3/16	1-3/16	5/16	29/32
MB25-3USC*	1/4" NPT	3-Way NC, NO	Piped	24 VAC, 120 VAC, 240 VAC, 12 VDC, 24 VDC	.035	.050	2-27/32	1-1/2	1-27/32	1-3/16	1-3/16	5/16	29/32

\*Valve can be piped either normally closed (NC) or normally open (NO).  
NOTE: All models consume 7 watts of power. Lead wires measure 16" in length.

# Product Features

## Features & Benefits

### Binary Valves

The USV-100 provides alternating outputs from a single input port. The valve has two outputs which are selected alternately by applying a pulsing, on-off air signal to the input port. USV-100 will not function properly with a sustained signal.



USV-100



USV-250

## Technical Data

Technical Specification	100 Model	250 Model
Operating Pressure	35-100 PSI	35-100 PSI
Flow to atmosphere	4 SCFM @ 100 PSI	36.9 SCFM @ 100 PSI
Permissible Mediums	Air and Inert Gas	Air and Inert Gas
Ambient Temp. Range	10° F to 120° F (-12° C to 49° C)	10° F to 120° F (-12° C to 49° C)
Lubrication	Recommended	Not Necessary
Flow	.12 C <sub>v</sub>	0.75 C <sub>v</sub>

## How It Works

### How It Works

When pressure is applied to port 1, it flows through the valve to provide an output at port 2. When the pressure is released from port 1, the valve changes over so that when pressure is next applied at port 1, air flows out through port 3. Release of the pressure again changes the valve back to its original position. Therefore, each time pressure is applied and released to port 1, outputs 2 and 3 change over.

NOTE: The air signal must be fully exhausted to enable the valve to change over properly.

Power models (USV-250) provide the same binary function as the 100 model but, in addition, offer full 4-way control power. They are suitable for direct connection to double-acting air cylinders. The USV-250 features a positive feed back from the outputs, eliminating incorrect sequential operation caused by poor signal performance.

5/32" Push-In Fittings

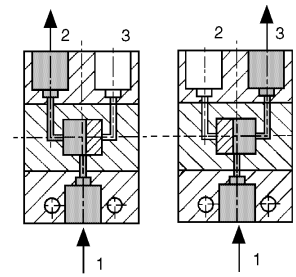

USV-100

## How To Specify

## Dimensions

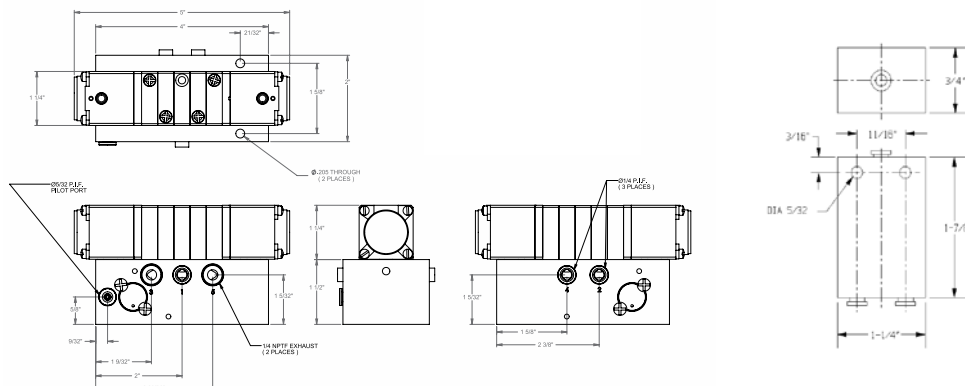

## Features & Benefits

### Air Timers Delay Signal

Air timers are used to delay the air signal coming in or out of an air component. Depending on the model, the delay may be adjusted from 0.75 to 60 seconds. Input port is indicated by a yellow dot.

Timers are available in either normally closed (NC) or normally open (NO) models. Normally closed models are used to time in and normally open models are used to time out. Once set, timers are accurate for repeatability to 10% with regulated air pressure.

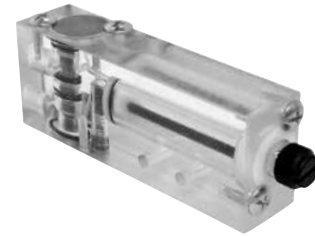

KLC-110

## Technical Data

General Specifications	
Filtration:	40 Micron filtration recommended
Lubrication:	30 wt. non-detergent oil
Pressure Range:	50-150 PSI (NC); 40-150 (NO)
Mounting:	(2) 11/64 clearance holes
Life Expectancy:	1,000,000 cycles
Temperature Range:	50° F to 120° F (10° C to 49° C)
Port Sizes/Material:	1/8" / Acrylic

## How It Works

### Timing In (Normally Closed) Circuit

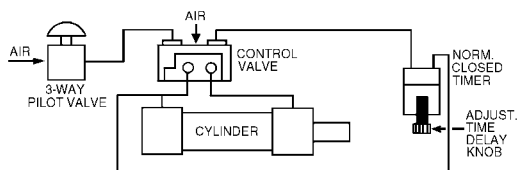

In this circuit, the 3-way valve is actuated and air is sent to the control valve. The control valve shifts, sending air through port A to the cylinder, which extends. Air also flows to the timer where it begins to time to the pre-setting. Once reached, the timer opens, allowing the air to flow through to the control valve's other pilot port, shifting the valve back. Air flows through port B, retracting the cylinder.

### Timing Out (Normally Open) Circuit

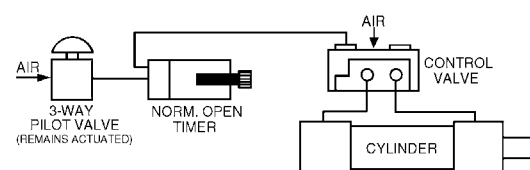

When the 3-way valve is actuated, air flows through the NO timer to the control valve. The 3-way valve remains actuated. The control valve shifts, sending air through port A to the cylinder, which extends. At the same time, the timer begins to time to the pre-setting. Once reached, the timer closes, blocking off the air flow to the control valve, which spring returns. Air flows through port B, retracting the cylinder.

## How To Order

Model Number		Range	Ports	Length	Width	Height
NC	NO					
KLC-101	KLH-101	0-1 sec.	1/8"	4"	1"	1-1/2"
KLC-105	KLH-105	0.75-5 sec.	1/8"	4"	1"	1-1/2"
KLC-110	KLH-110	1-10 sec.	1/8"	4"	1"	1-1/2"
KLC-212	KLH-212	15 sec-2 min.	1/8"	4 7/8"	1-1/2"	1 7/8"
KLC-230	KLH-230	2-30 sec.	1/8"	4 7/8"	1-1/2"	1-7/8"
KLC-260	KLH-260	10-60 sec.	1/8"	4 7/8"	1-1/2"	1 7/8"

NOTE: NC timers have a green spool; NO timers have a red spool. For specific timers, consult factory.

# Product Features

## Features & Benefits

### Pneumatic Impulse Relay Valves

Impulse relay valves allow you to shift a double-pressure piloted or double bleed piloted valve, even though there are overlapping pilot signals. Relay valves convert a sustained air flow from a three-way pilot valve into a momentary pulse or bleed, which shifts a control valve and then closes.



414B  
Pressure Type

415B  
Bleed Type

## Technical Data

### General Specifications

Mounting:	Mounts directly to control valve with nipple fitting
Body Construction:	Aluminum
Pressure Range:	35 to 125 PSI
Lubrication:	10 wt. non-detergent oil

NOTE: Required inlet pressure must be delivered all at once.

## How It Works

### Sample Circuit Using 414B (Pressure Type)

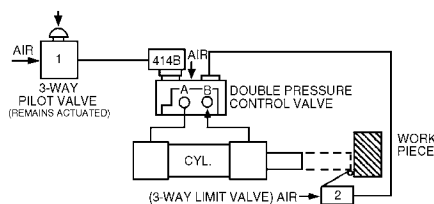

When actuated, the 3-way valve sends a signal to 414B, which emits a signal to the control valve. The 3-way valve remains actuated. The valve shifts, allowing air to flow through port A, extending the cylinder. 414B senses the back pressure caused by the shifted valve, closes, and exhausts. Since the signal from valve #1 is blocked by the closed 414B, valve #2 (when actuated) shifts the control valve back. Air flows through port B, retracting the cylinder.

### Sample Circuit Using 415B (Bleed Type)

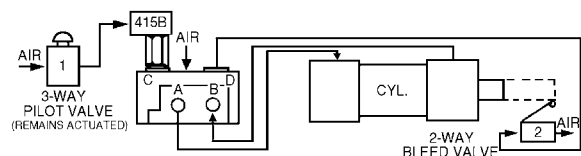

Air enters a double bleed piloted valve, flows through ports C and D, and is blocked by the 415B relay and valve #2. When actuated, the 3-way valve #1 sends an air signal to the 415B. The 3-way valve remains actuated, 415B exhausts, shifting the control valve and extending the cylinder. The 415B senses the back pressure from the shifted valve and closes, blocking off the air flow from valve #1. This allows valve #2 (when actuated) to bleed air, allowing the control valve to shift. Air flows through port B, retracting the cylinder.

## How To Order

Model Number	Ports	Type	Length	Width	Height
414B	1/8" NPTF	Pressure	1-59/64"	3/4"	1-1/4"
415B	1/8" NPTF	Bleed	1-59/64"	3/4"	3-11/16"



## Features & Benefits

### Pneumatic Stroke Completion Sensors

Stroke Completion Sensors (SCS) mount directly on cylinder ports to provide an air signal when rod motion stops, even when the full stroke length is not used. Stroke completion sensors automatically adjust to variable strokes, replacing limit and reed switches in clamping, holding and sequencing tasks.

Sensors work by comparing supply pressure to exhaust pressure. Once the pressure drops on the exhaust side of the cylinder, the sensor will emit an air signal. Stroke completion sensors are not recommended for cylinder "inching" operations with pressure held valves.



SCS-112

## How It Works

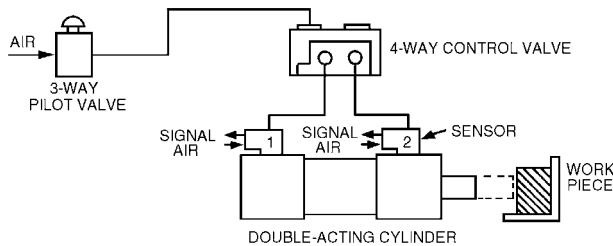

In this sample circuit, sensor #1 provides an air signal when the cylinder rod is retracted. When the four-way control valve shifts, air flows to the cylinder, which extends. This causes sensor #1 to shut off. The cylinder rod stops when it reaches the work piece or end of stroke, causing sensor #2 to emit an air signal. This air signal may be used to actuate another valve or for sequencing operations.

When using a flow control valve in conjunction with a stroke completion sensor, place the flow control valve between the control valve and the sensor.

## How To Order

Model Number	Mtg. Thread	Pilot Tubing	Pressure Range	Length	Width	Height
SCS-112	1/8" NPT	5/32" OD	60 to 120 PSI	2 3/16"	29/32"	1"
SCS-250	1/4" NPT	5/32" OD	60 to 120 PSI	2 3/16"	29/32"	1"
SCS-375	3/8" NPT	5/32" OD	60 to 120 PSI	2 3/4"	1 17/64"	1 1/16"
SCS-500	1/2" NPT	5/32" OD	60 to 120 PSI	2 3/4"	1 17/64"	1 1/16"

Temperature Range 5° F to 140° F

# Product Features

## Features & Benefits

### Air to Electric Switches

Air to electric switches convert air signals into electrical signals, which is ideal for actuating solenoid power valves or other electric components. Switches may be wired normally closed or normally open.

Actuator head model MPE-B may be easily mounted on any plunger-type switch; operating range is 8 PSI (minimum) to 100 PSI (maximum) and is not adjustable to a specific pressure.

Switch models MPE-BZ and MPE-BZE are single pole double throw (SPDT), have a 15 amp capacity for normal, low resistance electrical circuits and are UL and CSA listed. Solder terminals accept up to #14 wire.

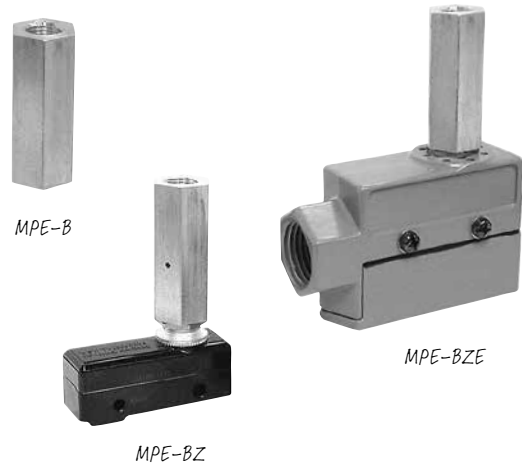

## How To Specify

### Dimensions

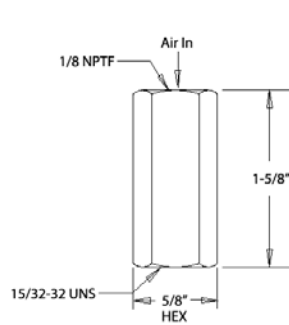

MPE-B (Actuator Head)

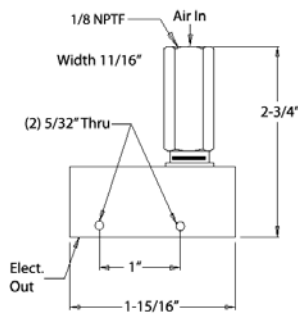

MPE-BZ

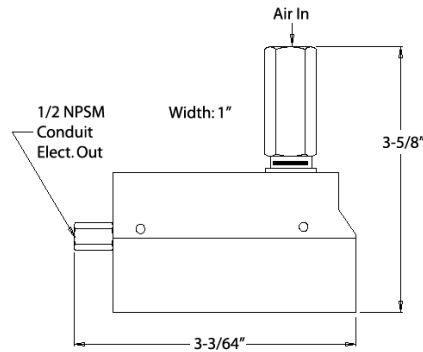

MPE-BZE

## How To Order

Model Number	Description
MPE-B	Actuator Head Only
MPE-BZ	Actuator Head and Switch, 15 Amp
MPE-BZE	Actuator Head, Switch and Enclosure, 15 Amp

## Features & Benefits

### Ideal for Mobile Equipment Applications

2-position ACV valves can be used for four-way directional control or as a three-way pilot valve. Its function indicator has been designed directly into the control knob and is visible only when the valve is in the energized or open position. In the unoperated (closed) position, the indicator ring is concealed within the knob assembly.

ACV features an optional interlock reset port which can be used to automatically return the valve to the closed position. Designed for mobile equipment operations to avoid stall conditions, the interlock feature is used to ensure that the PTO cannot be operated while the vehicle is in motion.



ACV-R25  
Unactuated



ACV-R25-SR Actuated

## Technical Data

General Specifications	
Media:	Air to 145 PSI (10 Bar)
Min. Pressure to Reset Port:	50 PSI
Flow (5/32" models):	0.053 C <sub>v</sub>
Flow (1/4" models):	0.12 C <sub>v</sub>
Neck Diameter for Panel Mounting:	11/16"
Body:	Plastic
Spool:	Brass
Fittings:	Brass and Plastic
Seals:	Nitrile
Temperature:	-4° F to 122° F (-20° C to 50° C)

## How It Works

### Air or Electric Reset

The reset port can be connected to the handbrake line to force valve "shutoff" whenever the handbrake is released. This would prevent the simultaneous consumption of energy from auxiliary equipment and the moving vehicle, a situation likely to result in a stall condition or equipment damage. On electrical interlock models, removing the electrical supply will force shutoff.

ACVs are rear ported to simplify dashboard or panel mounting. All mountings are supplied with integral push-in fittings (for 6mm or 1/4" tube). Simply push the tube directly into the valve.

### Sample Hook-Up To Mobile PTO System

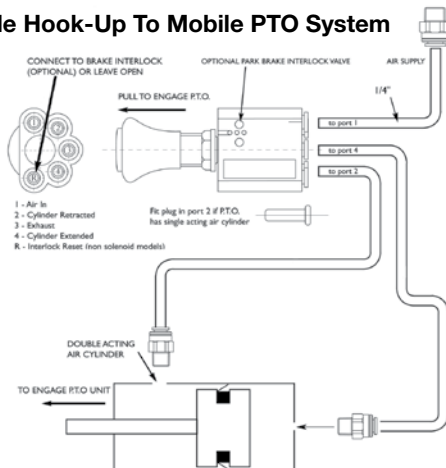

## How To Specify

### Dimensions

#### 1/4" Models

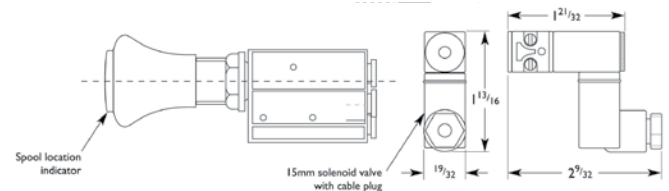
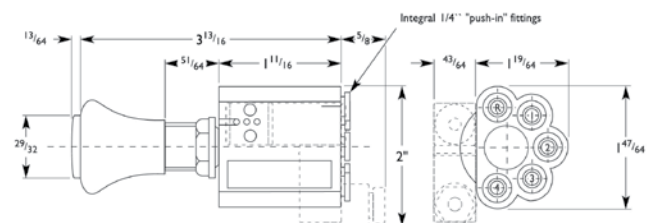

# How To Order

## How To Order

### ACV-R 25-AR-B

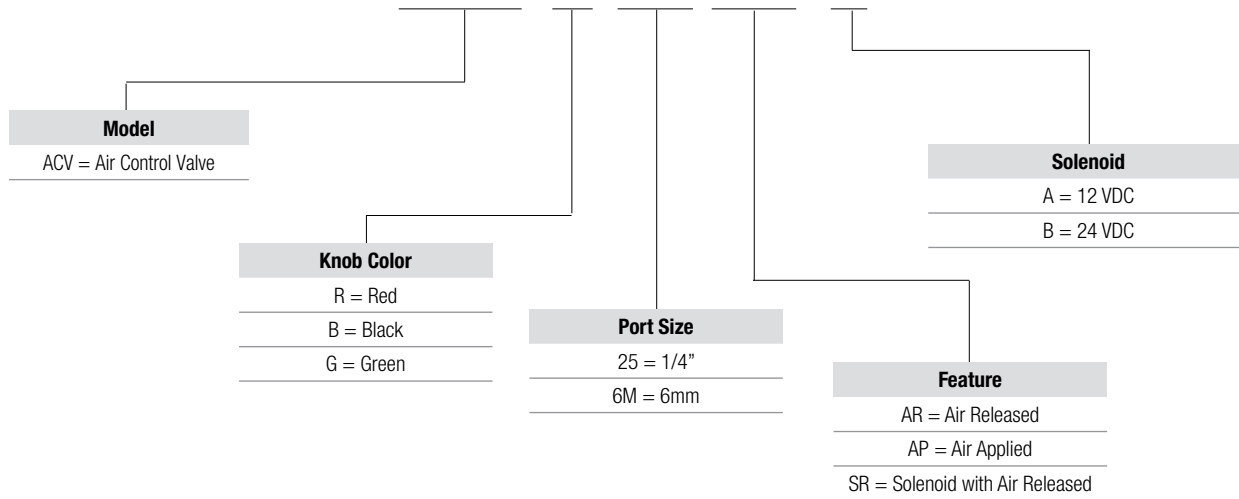

## Features & Benefits

### Smooth Laminar Flow

The unique construction of Dyla-Trol® assures a perfectly tapering flow. This unprecedented smoothness is made possible by the “iris” type orifice mechanism. Where needle-type flow controls generate turbulence as they close, Dyla-Trol® maintains an even 360° laminar flow regardless of the setting.

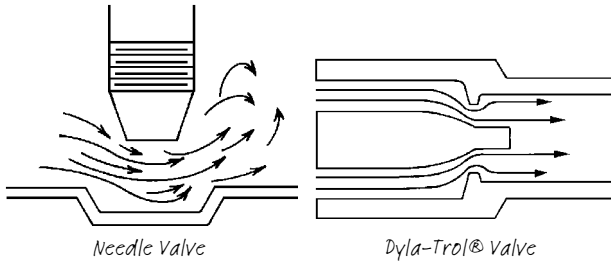

### Precise-Metering Flow Control

Fine tune the speed of your cylinders with precise-metering Dyla-Trol® valves. No other flow control provides such accurate control of cylinder motion.

For best results, locate flow control valves right on the cylinder ports with the “free flow” direction pointing toward the cylinder. Air exhausting from the cylinder will then be metered. Controlling air entering the cylinder produces a less smooth motion.

NOTE: While Dyla-Trol® are most often used to adjust cylinder speed, they are ideal for use wherever air or oil flow is to be controlled.

### High Repeatability

The fast-acting check mechanism in each free flow model responds to very slight changes in pressure. This guarantees fast resetting and dependable repeatability with each cycle.

### Compact Inline Design

The convenient inline design makes flow setting and plumbing easy. The hexagonal adjusting sleeve, which may be turned by hand, is only slightly greater in diameter than the tubing and has no protuberances to impair hook-up.

### Each Valve Factory “Tuned” for Accuracy

To accomplish the perfect orifice concentricity that is necessary to produce the high performance of Dyla-Trols, each sleeve and body set is permanently mated during production.

## Technical Data

### Temperature Range

-40° F to 250° F (-40° C to 121°C)

### Control

Models MF1-12, MF1-25, MF1-37 and MF1-50 are controlled flow in one direction, free flow in the other. MF2-12, MF2-25, MF2-37 and MF2-50 are controlled flow in both directions.

### Typical Cylinder Hook-Up

In this circuit, flow control #1 controls the outward movement of the cylinder rod and flow control #2 controls the return speed.

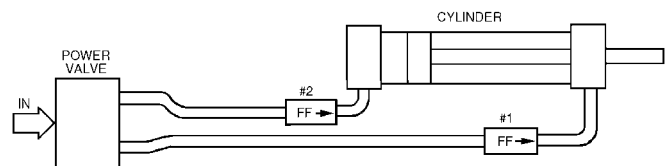

# How To Order

## How To Order

### Models and Specifications

Flow Direction	MF1-02	MF1-04	MF1-06	MF1-08	MF1-12	MF1-25	MF1-37	MF1-50
Max. Pressure in PSI	250 Air 250 Oil	250 Air 250 Oil	250 Air 250 Oil	250 Air 250 Oil	250 Air 1000 Oil	250 Air 1000 Oil	250 Air 1000 Oil	250 Air 1000 Oil
Max. Flow @ 100 PSI $C_v = 0.1$	8 CFM $C_v = 0.1$	7 CFM $C_v = 0.1$	7 CFM $C_v = 0.1$	7 CFM $C_v = 0.1$	47 CFM $C_v = 0.8$	66 CFM $C_v = 1.2$	149 CFM $C_v = 2.6$	173 CFM $C_v = 3.1$
Body	Brass	Brass	Brass	Brass	Aluminum	Aluminum	Aluminum	Aluminum
Length	1-1/4"	2-1/2"	2-7/16"	2-1/2"	2"	2-1/2"	2-7/8"	3-1/4"

### Valve Symbols

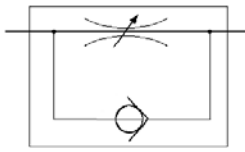

MF1 Style

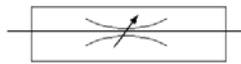

MF2 Style

## Features & Benefits

### For Safer Operation of Your Machinery

CSVs are two-hand anti-tiedown controls. When used, they provide safer operation of air presses, drill fixtures, clamping fixtures, cylinders, valves, or light assembly equipment. Models 101, 101LS, 102, 102LS and 103 have compact and completely self-contained controls, recessed actuation buttons built in the ends and a universal mount for convenient positioning. For remote two-hand, anti-tiedown operations, see model CSV-107.

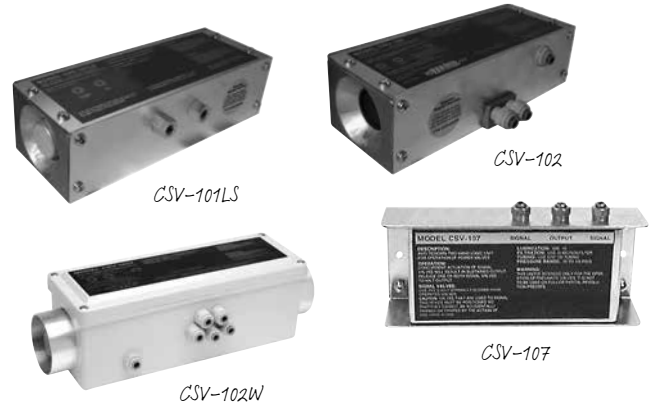

## How It Works

### Function of CSVs

Concurrent actuation of the recessed buttons generates a signal. Releasing one or both buttons immediately stops the signal which cannot be re-instituted until both buttons are again actuated concurrently.

Low Stress (LS) models are for high production applications where operator fatigue is a concern. Needing only 6 ounces of force to actuate, LS units ease the stress on worker's hands and wrists and greatly reduce the risk of repetitive motion disorders. Standard models require 18 ounces of force or more to actuate.

Consult website for dimensional drawings.

### CSV-101, CSV-101LS & CSV-101W

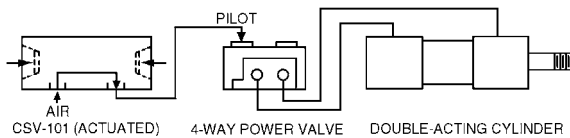

Actuates any 3 or 4-way air piloted, spring return power valve or small single-acting cylinders. ( $C_v = 0.11$ )

### CSV-102, CSV-102LS & CSV-102W

Complete power package containing a 4-way power valve

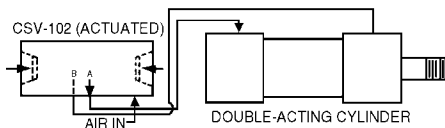

( $C_v = 1.00$ ) for direct actuation of single-acting or double acting air cylinders. Actuation sends a sustained air flow to one cylinder port. Releasing one or both buttons shifts the flow to the other cylinder port. Built-in mufflers reduce sound levels.

### CSV-103

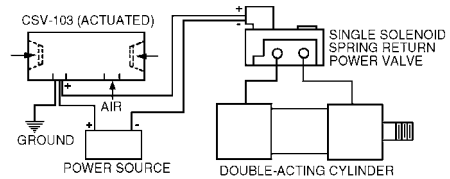

Converts an air signal into an electrical signal for actuating solenoid valves or other electrical devices. Concurrent actuation of the recessed buttons produces an electrical output. Releasing one or both buttons stops the output. The CSV-103 will not recycle until both triggers are released and again actuated concurrently. Internal switch rated at 15 amps, 480 VAC. Includes lead wire and receptacle.

### CSV-101W & CSV-102W

CSVs are designed for use in a wash-down environment. The units provide the same pilot and power functionality of the CSV-101 and CSV-102, respectively. The logic circuitry is housed in a fiberglass industrial control panel enclosure, providing excellent chemical and corrosion resistance.

### CSV-107 Logic Unit Responds To Remote Signals

CSV-107 is designed to actuate 3 or 4-way air piloted, spring return power valves or directly power smaller single-acting cylinders. A signal can only be initiated by concurrent actuation from two remote inputs. Releasing one or both buttons immediately stops the signal and the unit cannot recycle until both signals are again simultaneously actuated. ( $C_v = 0.11$ )

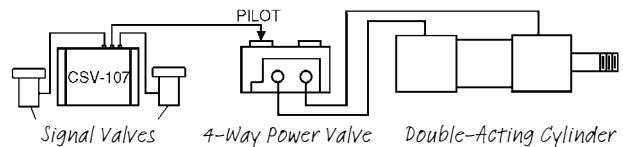

The CSV-107 may be purchased alone or with low stress signal valves (LS1, LS2). For information on Bimba Low Stress Valves, which are offered with CSV Low Stress (LS) units, please refer to page 19. Push-to-connect fittings included on all pneumatic models.

# How To Order

## How To Order

Model Number	Function	Ports (NPTF)
CSV-101	Actuation of Power Valve	(2) 1/8"
CSV-101W	Actuation of Power Valve	(3) 1/8"
CSV-101LS	CSV-101, with Low Stress Actuation	(2) 1/8"
CSV-102	Direct Actuation of Air Cylinder or Air Press	(3) 1/4" Fittings
CSV-102W	Direct Actuation of Air Cylinder or Air Press	(6) 1/4" Fittings
CSV-102LS	CSV-102, with Low Stress Actuation	(3) 1/4" Fittings
CSV-103	Electrical Actuation of Solenoid Valve	(1) 1/8"
CSV-107	Remote Logic Unit Only	
CSV-107LS1	Logic Unit, (2) LTV-PBG Low Stress Valves	(3) Fittings Included for 5/32" OD Tube
CSV-107LS2	Logic Unit, (2) LTV-PBGF Low Stress Valves	

NOTE: Operating pressure range is 70-100 PSI.

Warning: CSVs are intended to operate pneumatic valves and cylinders. They are not meant to be used on full or partial revolution fly wheel presses, power brakes, or other similar devices.

Warning: Actuators for CSV-107 must be positioned so that they may not be accidentally tripped or operated in an unsafe manner. Do not actuate CSV-107 with foot operated valves.







# Production Devices

Bimba's line of Production Devices features specialized presses and press accessories to reduce production and installation costs. Each press comes fully-assembled, ready to crimp, heat seal, bend, form, and perform all of your specialized press requirements.

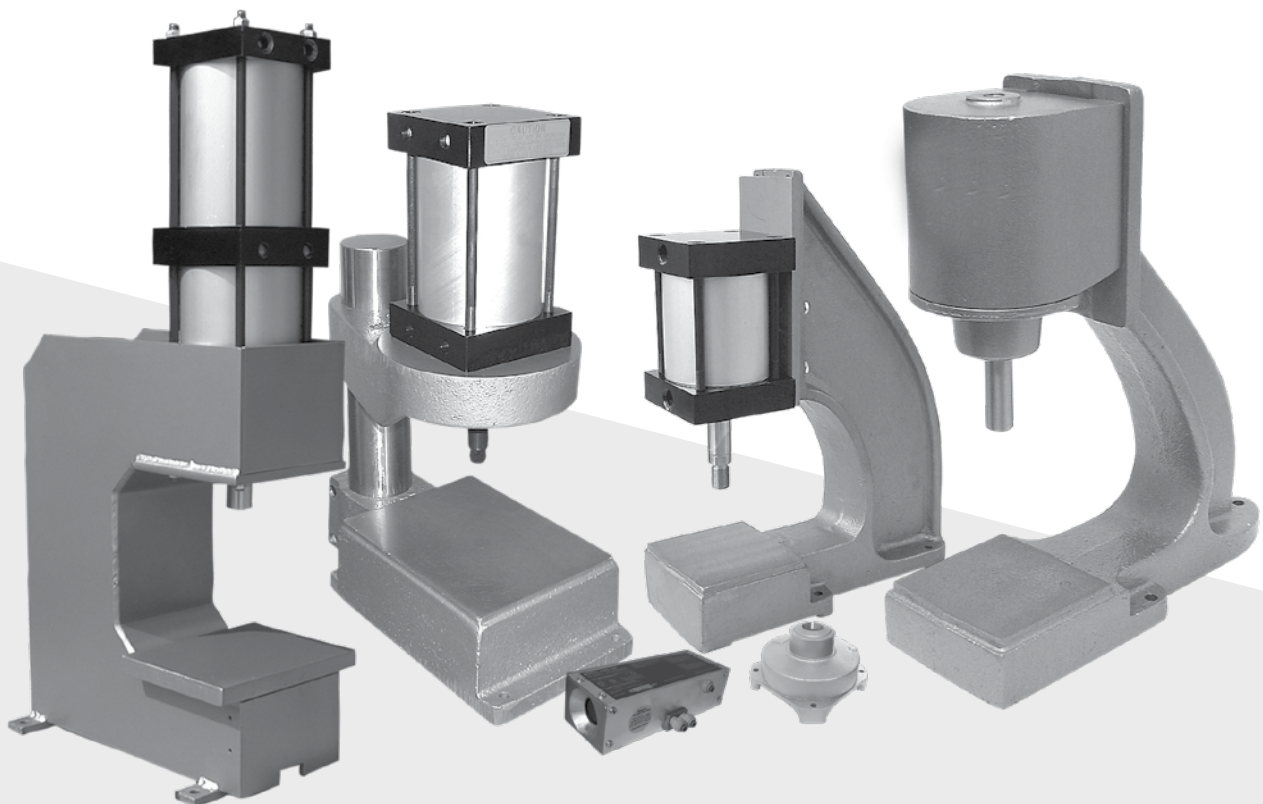

# Contents

---

**101** Air Presses

- 101 – Features & Benefits
- 102 – Dimensions
- 103 – Options
- 103 – How To Order

---

**104** Heavy Multi-Stage Press

- 104 – Materials & Technical Data
  - 104 – Dimensions
  - 105 – How To Order
- 

---

**106** Collet Fixtures

- 106 – Features & Benefits
  - 106 – Dimensions
  - 106 – How To Order
-

## Features & Benefits

### Air Presses Automate Tasks

Economical air powered presses reduce production costs by automating crimping, heat sealing, bending, forming, pressing, swaging, riveting and burnishing operations. Easy hook-up. Just attach to your shop air supply. No wiring, pumps, or motors needed.

### Single-Acting Air Presses

Besides the AP-42P shown on this page, Bimba offers two other single-acting alternatives. AP-122 combines a 4" bore single-acting cylinder (H-122) with the AP-400M press stand. AP-283 combines a 6" bore cylinder with the AP-600M press stand. Full dimensional drawings are given on page 102.



*AP-42P  
1/4 Ton Arbor Press  
Versatile, light-duty press.  
Single-acting, spring return.*



*CP-400P  
3/4 Ton Column Press  
Column provides infinitely  
variable daylight settings and  
permits radial swing.*



*AP-400P  
3/4 Ton Arbor Press  
Heavy-duty cast iron frame  
is extremely rigid.*



*AP-600P  
1-3/4 Ton Arbor Press  
Welded steel plate frame. Cylinder  
mount and table are milled to  
provide precise rod alignment.*

# How To Specify

## Product Information

### Dimensions

This press combines the AP-42M press stand with a Bimba H-42 single-acting cylinder (2 1/4" bore, 2" stroke). Cylinder details are on page 77.

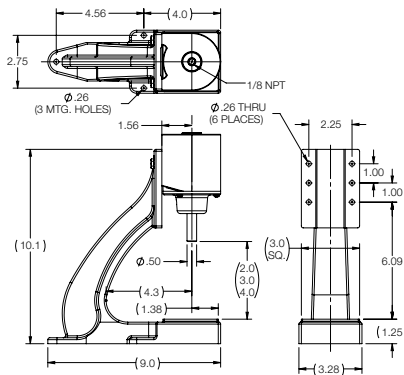

**AP-42**  
**Shipping Weight:**  
*Stand Only = 9 lbs.*  
*Stand/Cyl. = 10 lbs.*

For non-standard double-acting service with strokes up to 4", use pages 54-55 to create a 4" bore cylinder for use with this stand.

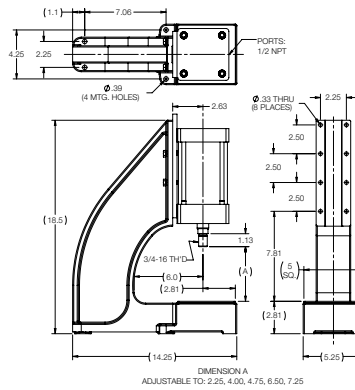

**AP-400**  
**Shipping Weight:**  
*Stand Only = 45 lbs.*  
*Stand/Cyl. = 52 lbs.*

This press combines the AP-400M press stand with a Bimba H-122 single-acting cylinder (4" bore, 2 5/8" stroke). Cylinder details are on page 77.

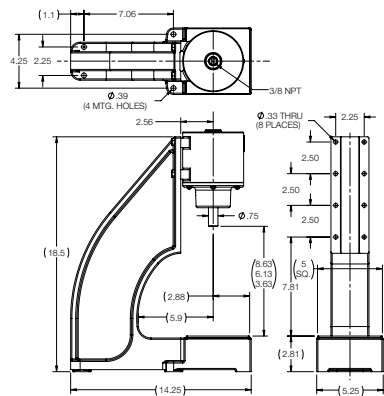

**AP-122**  
**Shipping Weight:**  
*Stand Only = 45 lbs.*  
*Stand/Cyl. = 52 lbs.*

For other stroke lengths, heavy-duty or other options, use pages 54-55 to create any 4" bore cylinder for use with this press stand.

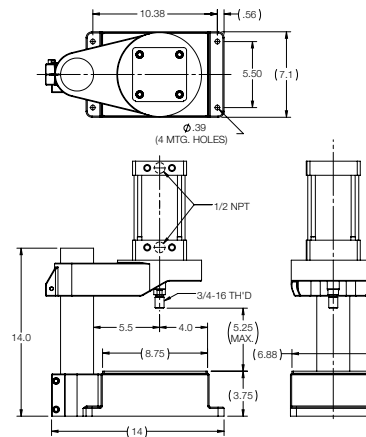

**CP-400**  
**Shipping Weight:**  
*Stand Only = 90 lbs.*  
*Stand/Cyl. = 105 lbs.*

This press combines the AP-600M stand with Bimba's #6040303 (H-283 with 3" longer ram, p. 77) single-acting cylinder (6" bore, 3" stroke). A PL-600 cylinder-to-stand adapter plate is required to mount this cylinder.

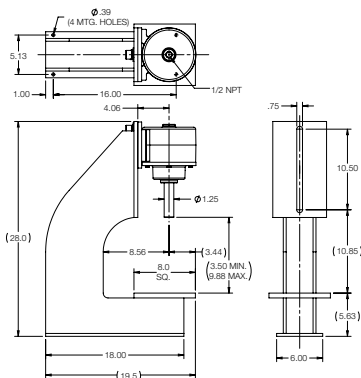

**AP-283**  
**Shipping Weight:**  
*Stand Only = 85 lbs.*  
*Stand/Cyl. = 125 lbs.*

For non-standard double-acting service with strokes up to 6", use pages 54-55 to design a 6" bore cylinder for use with this stand.

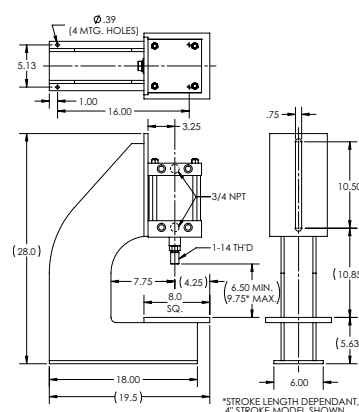

**AP-600**  
**Shipping Weight:**  
*Stand Only = 85 lbs.*  
*Stand/Cyl. = 120 lbs.*

## Options

### Rod Speed Reduction

To control the downward speed of double-acting presses, place a Bimba Dyla-Trol valve (see page 56) in the bottom cylinder port so that incoming air flows freely and exhausting air is metered. Model MF1-25 is suitable for the control of all presses under most conditions.



### Double Rod Option (DR)

Double-acting press cylinders may be ordered with the piston rod extending from both ends. This minimizes rod deflection and make it possible to adjust stroke length. When a CP-400 is ordered with double rod, spacers are supplied to facilitate adjustment.

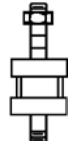

### Two Hand Control Unit

Models with a "C" suffix are supplied with a two hand anti-tiedown unit. Recessed trigger buttons, located in each end of the compact unit, require the press operator to use both hands concurrently to operate the press. Models CP-400C and AP-400C include the CSV-102, which has a built-in power valve. Model AP-600C includes the CSV-101 and a 1/2" power valve (C5-3). All air logic. No electrical wiring. See page 95 for the two hand controls. See pages 24-26 for the power valve.

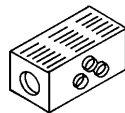

### Press Speed Boost

Quick exhaust valves increase rod speed by allowing exhaust air to be dumped right at the cylinder instead of passing back through the directional valve. If speed is to be increased in both directions on double-acting presses, use one QEV in each port. Use model QEV-3 with 1/4 ton presses and model QEV-2B on 3/4 and 1-3/4 ton models. See page 106 for more information regarding QEVs.

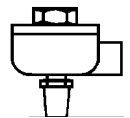

See page 102 for Air Press dimensions.

## How To Order

	Description	1/4 Ton Arbor Press	3/4 Ton Column Press	3/4 Ton Arbor Press	1-3/4 Ton Arbor Press
	Press Stand Only	AP-42M	CP-400M	AP-400M	AP-600M
	Cylinder Mounted on Stand **	AP-42P	CP-400P	AP-400P	AP-600P
	Complete Press with Two Hand Controls (Not Piped)	-	CP-400C	AP-400C	AP-600C
	Double Rod Option (DR)	NA	•	•	•
	Non-Rotating Option (NR)	NA	•	•	•
<b>Specifications</b>					
	Cylinder Bore (in.)	2-1/4	4	4	6
	Thrust at 100 PSI (lbs.)	353	1257	1257	2827
	Standard Stroke Length (in.)	2 (Spr. Ret.)	4*	2 1/2*	4*
<b>Surface</b>	Table Width and Depth (in.)	3 x 3	6-7/8 x 8-3/4	5 x 5	8 x 8

NOTE: Standard column for Column Press is 14" long. Longer column (18" max.) is available upon request.

\* Additional stroke available to 4" on AP-400 and to 6" on AP-600. Consult factory.

\*\* Consult website for press hookups.

# Product Features

## Features & Benefits

### Heavy Multi-Stage Press

Bimba's latest press utilizes multiple stages to achieve a dramatically increased output force. A standard shop air input (110 PSI) can achieve a push output force of up to 6057 lbs. The standard model has two stages, but upon request Bimba can provide more stages which means higher output force at an even lower input force.

Economical air powered presses reduce production costs by automating crimping, heat sealing, bending, forming, pressing, swaging, riveting and burnishing operations. Easy hook-up: just attach to your shop air supply. No wiring, pumps, or motors needed.



HP-600P

Materials	
<b>Rod Bearing</b>	Teflon-impregnated, hardcoated aluminum
<b>Heads</b>	Machined from solid aluminum bar; black anodized
<b> Tubes</b>	Aluminum hard anodized to 60 Rc
<b>Piston</b>	Solid high alloy aluminum
<b>Piston Rod</b>	High tensile ground and polished hard chrome plated steel
<b>Piston &amp; Rod Seals</b>	Wear compensating Buna-N vee rings. Self-lubricating seals also available (see Option NL).
<b>Tube Seals</b>	Buna-N O-rings
<b>Rod Wiper</b>	Dupont Teflon®
<b>Tie Rods</b>	High tensile steel torqued to allow for flexure.
<b>Stand</b>	Welded steel frame

## Technical Data

Operating Specifications	
Temperature Range:	-40° F to 250° F (-40° C to 121° C)
Lubrication:	For maximum cylinder life, non-detergent petroleum-based oil is recommended. Non-lube seals available.
Filtration:	Standard 40 micron filter for maximum life.
Maximum Pressure:	110 PSI
Maximum Output Force:	6057 lbs.
Thrust Multiplier:	55*

\* To determine thrust at other inlet pressure, multiply factor by desired pressure.

## How To Specify

### Dimensions

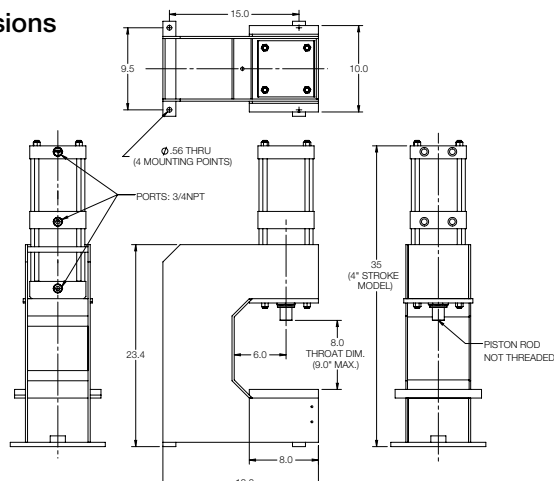



## How To Order

Model Number	Description
HP-600M	Press stand only
HP-600P	Cylinder mounted on stand
HP-600C	Complete press with 2 hand controls (not piped)

Specify:  
 Throat dimension "T" Min= 1/2" Max=9"  
 Stroke dimension "S" Min= 2" Max=9"

## HP-600P G2-T8.00-S4.00 CR

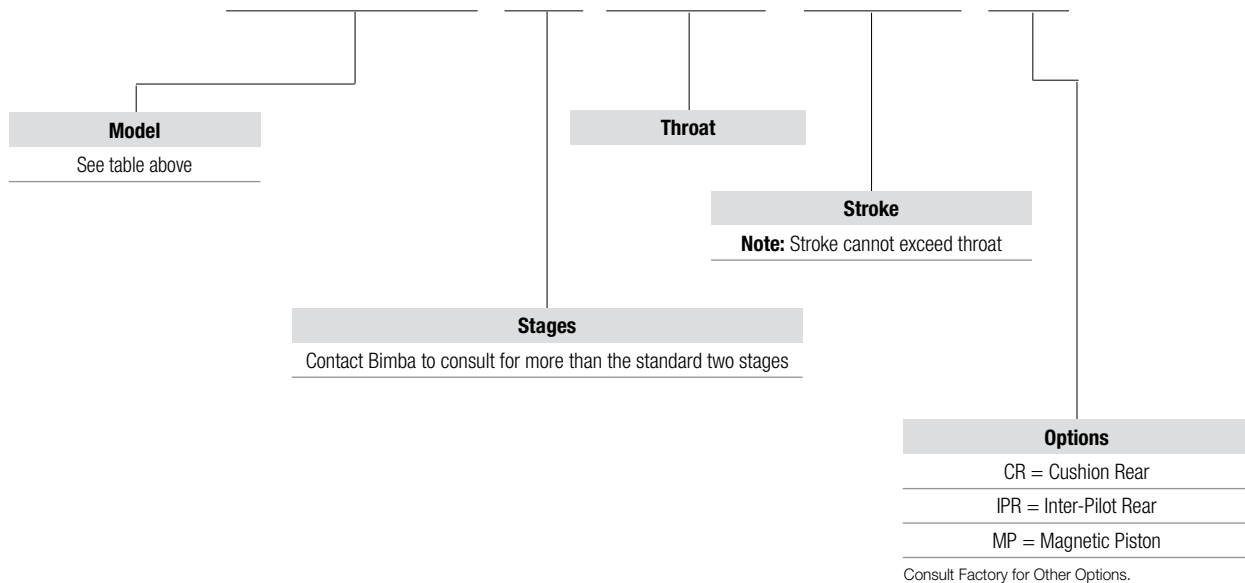

# Product Features

## Features & Benefits

### Collet Fixtures

Use collet fixtures to evenly and firmly grip round bars during drilling, machining, positioning, or assembling tasks, without marring the surface of the bars.

Workpieces may pass through the fixture. Model LS-1 accepts standard 5C collets. A collet wrench is supplied to simplify collet installation and removal. Bimba does not offer collets.

Double-acting collet fixtures must be actuated by a four-way valve. Model LS-1 at up to 40 ft-lbs at 100 PSI.

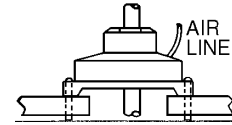

## How To Specify

### Dimensions

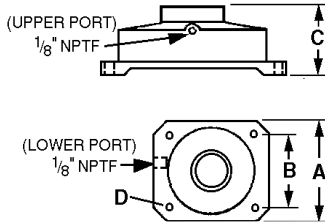

Model Number	Applied Holding Pressure @ 100 PSI; Max. 120 PSI	Collet Type	Round Stock Capacity	A (sq.)	B (sq.)	C	D (4)
LS-1	7,100 lbs.	5C	1"	7"	5-7/16"	4-9/16"	.390"





# Accessories

Many pneumatic applications need accessories to complete the circuit. Bimba offers everything, from DIN connectors to air silencers, manifolds to check valves, to make your pneumatic circuit operate at peak efficiency.

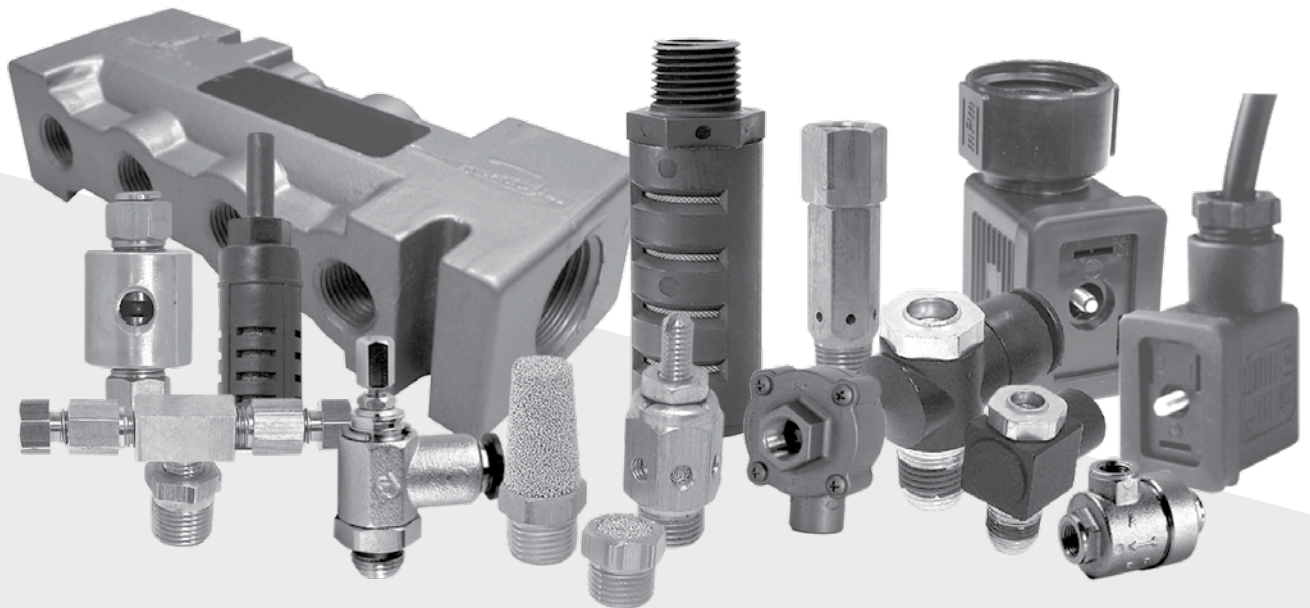

# Contents

---

**111** Right Angle Flow Controls

111 – Technical Data

111 – Dimensions

111 – How To Order

---

**112** Din Connectors & Manifold

112 – Features & Benefits

112 – DIN Connector Hook-Up  
Diagram

112 – How To Order

---

**113** Quick Exhaust Valves

113 – Features & Benefits

113 – Circuit Diagram

113 – Flow Patterns

113 – How To Order

---

---

**114** Shuttle & Check Valves

114 – Features & Benefits

114 – Flow Patterns & Technical Data

114 – Dimensions

114 – How To Order

---

**115** Air Silencers & Breathers

115 – Features & Benefits

115 – How To Order

---

**116** Reference - Cylinder Finder

---

**117** Reference - Valve Finder

---

**122** Reference - Custom Products

---

## Features & Benefits

### RAF & RAFK Series Right Angle Flow Controls

Bimba's right-angle flow control valves provide fast, accurate control in a convenient, compact package. Designed specifically for controlling flow to pneumatic actuators, they come standard with push-in fittings, pre-applied Teflon based thread sealant, an adjustment depending on the type, and convenient swivel feature for ease of tubing alignment. Both the RAF and RAFK mount directly to your cylinder's ports. The RAF adjustment is a recessed screw driver slot. The RAF-K has a knob adjustment that can be tightened once set. For precision in-line flow controls, see Bimba's Dyla-Trol® flow controls on page 93.

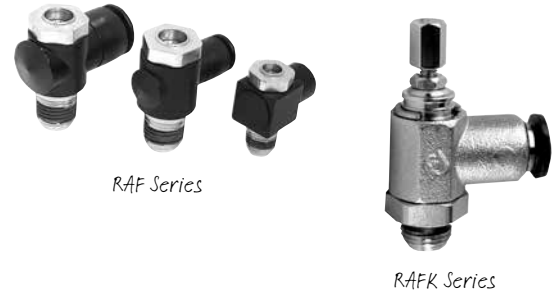

## Technical Data

RAF Specifications	
Materials:	Black Anodized Aluminum Body Zinc Plated Brass Fittings Stainless Steel Needle Buna-N Seals
Pressure:	15 -145 PSI
Temperature:	-14° F to 160° F (-26° C to 71° C)
Cracking Pressure:	5 PSI

RAFK Specifications	
Materials:	Brass-Nickel Plated Body NBR 70 Seals C72 Dacromet Shaft Clip Zinc Plated Brass Fittings Stainless Steel Needle Buna-N Seals
Pressure:	15 -145 PSI
Temperature:	0° F to 160° F (-18° C to 71° C)

## How To Specify

### Dimensions

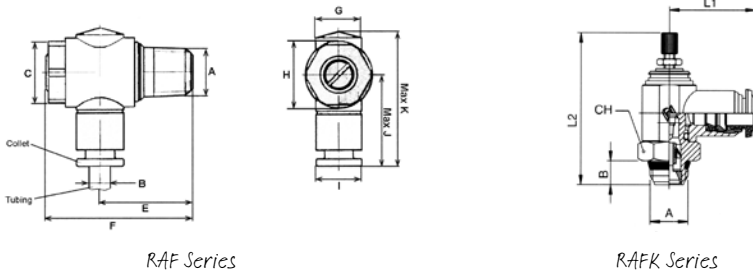

## How To Order

Model Number	A	B	C	E	F	G	H	I	J	K
RAF-5/32x2	1/8 NPFT	5/32"	.511	.780	1.26	.433	.591	.433	.843	1.24
RAF-4x2	1/8 NPFT	1/4"	.511	.780	1.26	.512	.591	.512	.944	1.33
RAF-4x4	1/4 NPFT	1/4"	.669	1.02	1.61	.512	.748	.512	1.06	1.50
RAF-6x4	1/4 NPFT	3/8"	.669	1.02	1.61	.709	.748	.709	1.06	1.57
RAF-8x8	1/2 NPFT	1/2"	.866	1.14	1.85	.709	.939	.709	1.14	1.73

Tube Part Number	O.D.	A Pipe Thd.	B	L1	L2 Min	L2 Max	CH
RAFK-2x2	1/8	1/8	.217	.827	1.614	1.830	.551
RAFK-5/32x2	5/32	1/8	.217	.827	1.614	1.830	.551
RAFK-4x2	1/4	1/8	.217	.866	1.614	1.830	.551
RAFK-4x4	1/4	1/4	.276	.984	1.850	2.086	.669

# Product Features

## Features & Benefits

### Female DIN Solenoid Connectors

Bimba's 11mm Industrial B-type DIN solenoids feature a totally encapsulated coil with 3 male prongs, allowing fast and easy connections. A female DIN connector (ordered separately) quickly attaches to the solenoid's prongs and is secured by a single screw.

Bimba offers 3 types of DIN connectors to facilitate connections to the solenoid. Model PVD1 is a connector with a 1/2" conduit entry and no lead wires. Model PVD2 also has a 1/2" conduit entry but includes 20" of cabled lead wire. Model PVD3 is a strain relief connector that includes 72" of cabled lead 18ga wire.



Model PVD1



Model PVD2



Model PVD3

### DIN Connector Hook-Up Diagram

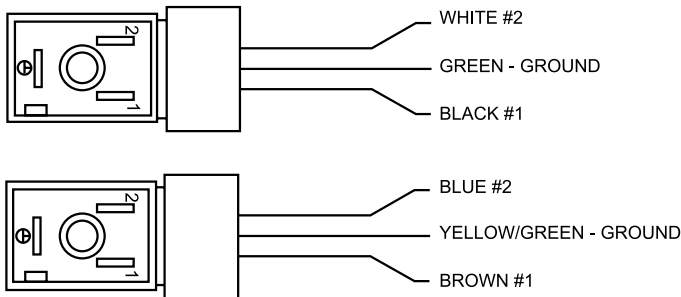

### Manifold

Use the #20 die cast aluminum manifold to simplify piping and cut down on plumbing time. A 3/8" NPTF inlet port provides a common air source for up to eight 1/8" NPTF outlets.

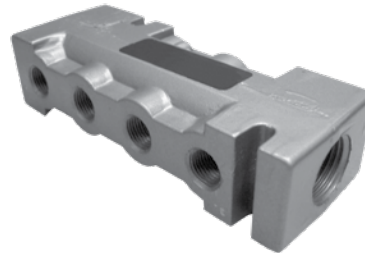

#### Dimensions

Model Number	Length	Height	Width
#20	4"	1"	1-1/2"



## Features & Benefits

### Quick Exhaust Valves

Quick exhaust valves (QEV) increase cylinder rod speed by dumping exhaust air directly at the cylinder instead of back through the control valve. Use one QEV in each cylinder port to increase rod speed in both directions.

Using a quick exhaust valve to increase cycling speed allows a smaller, less expensive control valve to be used.

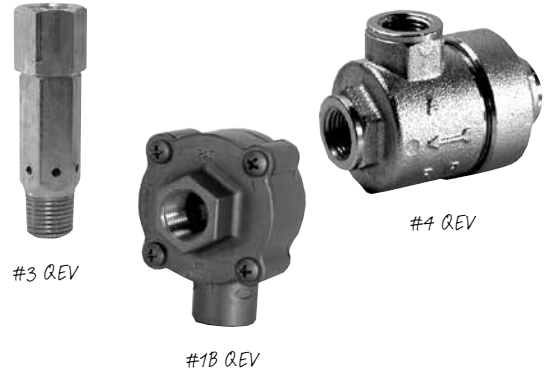

### Circuit with Quick Exhaust Valves

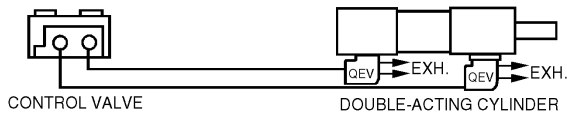

### Flow Patterns

#1B and #2B

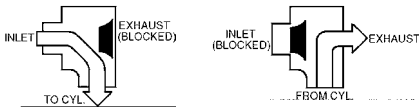

#4, #5 and #6



## How To Order

Model Number	Port	C <sub>v</sub>	Length	Width	Height
#3 QEV	1/8"	.10* .13‡	1/2"	1/2"	1-13/16"
#1B QEV	1/4"	2.71* 2.83‡	1-3/4"	1-7/8"	2-17/32"
#2B QEV	3/8"	3.13* 3.43‡	1-3/4"	1-7/8"	2-17/32"
#4 QEV	1/2"	3.25* 3.52‡	2.89"	1.02"	2.21"
#5 QEV	3/4"	3.78* 4.08‡	3.43"	1.26"	2.55"
#6 QEV	1"	4.12* 4.40‡	4.26"	3.15"	3.29"

\* Inlet port through cylinder port

‡ Cylinder port through exhaust port

Pressure: 30 - 125 PSI #3 QEV, #1B QEV and #2B QEV

15 - 150 PSI #4 QEV, #5 QEV and #6 QEV

# Product Features

## Features & Benefits

### Shuttle Valves

Use shuttle valves to actuate a cylinder or valve from either of two air sources. Available for 1/8" and 1/4" tubing.



SV-1



SV-2

### Flow Patterns

Cylinder Actuated by Source #1

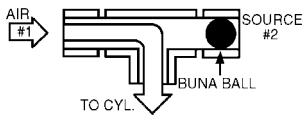

Cylinder Actuated by Source #2

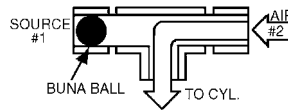

## How To Order

Model No.	Port	C <sub>v</sub>	Tubing	Body	Length	Width	Height
SV-2	1/8-27*	.04	1/8" OD	Brass	2"	7/16" Hex	15/16"
SV-1	1/8"	.32	1/4" OD	Alum.	2 3/4"	1"	1"

\* 1/8-27 NPT male

## Features & Benefits

### Check Valves

Bimba check valves are designed to allow full flow in one direction, and check or stop flow in the other direction.

## Technical Data

Specifications	
Materials:	Nickel Plated Brass Body and Piston NBR 70 Seals Steel Spring
Pressure:	30-120 PSI
Temperature:	0° F to 160° F (-18° C to 71° C)
Cracking Pressure:	3 PSI

### Dimensions

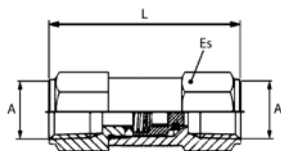

Part Number	A NPTF	L	Es
CV-2	1/8	1.437	.512
CV-4	1/4	1.850	.669

## Features & Benefits

### Air Silencers & Breathers

MM, MMS, and MML air silencers reduce exhaust noise by approximately 20%. MMB breather vents prevent contaminants from entering the air component. All models are constructed of sintered bronze (MML are also housed in plastic). MML is designed to have 15% less pressure drop than MM or MMS models. MMP air silencers feature a unique stem for quick connections to tube collets.

MMS Silencers not only serve as sound reducers, but are also low cost speed controls. An adjustable needle valve in the top of each MMS allows for the setting of exhaust rates.

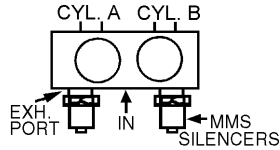

## How To Order

Model Number	Pipe Size	Length	Width	Height	Per Box
MM-019	#10-32*	45/64"	5/16" Hex	45/64"	20
MMB-125	1/8" NPT	7/16"	7/16" Hex	7/16"	20
MM-125	1/8" NPT	1-1/8"	7/16" Hex	7/16"	20
MMS-125	1/8" NPT	29/32"	1/2" Hex	1/2"	20
MML-125	1/8" NPT	2-1/8"	13/16"	13/16"	20
MMB-250	1/4" NPT	5/8"	9/16" Hex	9/16"	10
MM-250	1/4" NPT	1-3/8"	9/16" Hex	9/16"	10
MMS-250	1/4" NPT	1-11/64"	9/16" Hex	9/16"	10
MML-250	1/4" NPT	2-1/4"	13/16"	13/16"	5
MMP-250	1/4" OD Stem	2-47/64"	13/16"	13/16"	1
MMP-006	6mm OD Stem	2-47/64"	23/32"	23/32"	1
MMB-375	3/8" NPT	3/4"	11/16" Hex	11/16"	5
MM-375	3/8" NPT	1-1/2"	11/16" Hex	11/16"	5
MMS-375	3/8" NPT	1-17/64"	11/16" Hex	11/16"	5
MML-375	3/8" NPT	3-7/16"	1-1/4"	1 1/4"	5
MMP-375	3/8" OD Stem	3-7/64"	23/32"	23/32"	1
MMP-010	10mm OD Stem	3-7/64"	23/32"	23/32"	1
MMB-500	1/2" NPT	7/8"	7/8" Hex	7/8"	5
MM-500	1/2" NPT	1-7/8"	7/8" Hex	7/8"	5
MMS-500	1/2" NPT	1-17/64"	7/8" Hex	7/8"	5
MML-500	1/2" NPT	3-9/16"	1-1/4"	1-1/4"	5

\* Furnished with gasket

## Product Information

### Cylinder Finder

Bimba offers a wide selection of cylinder styles.



#### Dyna-Mation (DM/DM1/DM2)

NFPA Interchangeable  
Extruded Body Design  
1-1/2" Through 4" Bore Sizes  
3/4" and 1-1/8" Tie Rod  
Models Available



#### Heavy-Duty (HD1)

External Rod Bearing  
NFPA Interchangeable  
1-1/2" Through 6" Bore Sizes



#### Large Bore (HD)

NFP Style Cylinders  
Tie Rod Design  
Bore Sizes: 5, 8, 10, 12



#### Centaur (C)

Medium Duty Round  
Non-Lube Cylinder  
Easy To Mount  
1-1/8" Through 3" Bore Sizes



#### Space Saver (SS)

Highly Compact  
Low Profile Cylinder  
3/4" Through 4" Bore Sizes



#### Air Clamps (H)

Single-Acting Cylinders  
Adjustable Stroke Models  
Available  
1" Through 6" Bore Sizes



#### Miniature (M)

Fractional Stroke Cylinders  
Universal Mounting  
1/4", 3/8" and 1/2" Bores

## Mounting Options

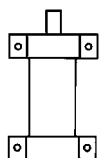

Foot

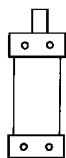

Bottom Flush

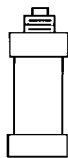

Nose

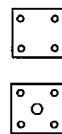

Front/Rear  
Flush

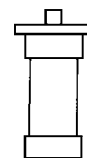

Front  
Flange

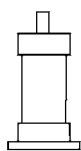

Rear  
Flange

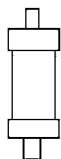

Pivot

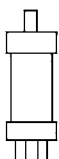

Clevis

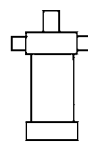

Front  
Trunnion

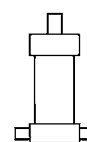

Rear  
Trunnion

## Product Information

Bore	Model Number	Rod Diam (in.)	Port Size (NPTF)	Stroke Availability (in.)	Double or Single Acting	Output at 100 PSI (lbs.)	Max. Air Inlet Pressure (PSI)	Pages
1/4"	MA-250	.14	10-32	to 2	DA/SA	5	125	74-76
	MF-250	.14	10-32	to 2	DA/SA	5	125	74-76
3/8"	MA-375	.17	10-32	to 2	DA/SA	11	125	74-76
	MF-375	.17	10-32	to 2	DA/SA	11	125	74-76
1/2"	MA-500	.25	10-32	to 2	DA/SA	20	125	74-76
	MF-500	.25	10-32	to 2	DA/SA	20	125	74-76
3/4"	DM-075	5/16	1/8	Any	DA	44	250	46-48
	SS-075	5/16	10-32	to 2	DA	44	250	72-73
1"	H-1	5/16	1/8	11/16	SA	68	150	74-76
	HOX01	5/16	1/8	0 to 2	SA	62	150	74-76
1-1/8"	DM-112	5/16	1/8	Any	DA	100	250	46-48
	C-112	5/16	1/4-28 or 1/8	Any	DA	100	250	68-70
	SS-112	1/2	10-32	to 3	DA	100	150	77-78
1-1/2"	DM1-150	5/8	1/4	Any	DA	177	250	49-55
	DM2-150	5/8	1/4	Any	DA	177	250	49-55
	HD1-150	5/8 or 1	1/4	Any	DA	177	250	56-63
	C-150	1/2	1/4	Any	DA	177	150	68-70
	SS-150	1/2	10-32	to 3	DA	177	150	72-73
2"	DM1-200	5/8	1/4	Any	DA	314	250	49-55
	DM2-200	5/8	1/4	Any	DA	314	250	49-55
	HD1-200	5/8 or 1	1/4	Any	DA	314	250	56-63
	C-200	5/8	1/4	Any	DA	314	150	68-70
	SS-200	5/8	1/8	to 3	DA	314	150	72-73
2-1/4"	H-41	1/2	1/8	1	SA	316	150	77-78
	H-42	1/2	1/8	2	SA	353	150	77-78
	H-43	1/2	1/8	3	SA	351	150	77-78
2-1/2"	DM1-250	5/8	1/4	Any	DA	491	250	49-55
	DM2-250	5/8	1/4	Any	DA	491	250	49-55
	HD1-250	5/8 or 1	1/4	Any	DA	491	250	56-63
	C-250	3/4	1/4	Any	DA	491	150	68-70
	SS-250	5/8	1/8	to 3	DA	491	150	72-73
3"	C-300	1	1/4	Any	DA	707	150	68-70
	SS-300	3/4	1/8	to 3	DA	707	150	72-73
	H-71, -72, -73	3/4	1/4	1, 2, 3	SA	682	150	77-78
3-1/4"	DM1-325	1	1/2	Any	DA	829	250	49-55
	DM2-325	1	1/2	Any	DA	829	250	49-55
	HD1-325	1 or 1-3/8	1/2	Any	DA	829	250	56-63
4"	DM1-400	1	1/2	Any	DA	1,257	250	49-55
	DM2-400	1	1/2	Any	DA	1,257	250	49-55
	HD1-400	1 or 1-3/8	1/2	Any	DA	1,257	250	56-63
	SS-400	3/4	1/8	to 3	DA	1,257	150	72-73
	H-122	3/4	3/8	2 5/8	SA	1,204	150	77-78
5"	HD-500	1 or 1-3/8	1/2	Any	DA	1,964	250	65-67
	DM-600	1 3/8	3/4	Any	DA	2,827	250	49-55
6"	HD-600	1-3/8 or 1-3/4	3/4	Any	DA	2,827	250	65-67
	H-283	1-1/4	1/2	3	SA	2,763	150	77-78
8"	HD-800	1-3/8 or 1-3/4	3/4	Any	DA	5,027	200	65-67
10"	HD-1000	1-3/4 or 2	1	Any	DA	7,854	200	65-67
12"	HD-1200	2 or 2-1/2	1	Any	DA	11,310	200	65-67

\*Specify "FOR HY USE" when ordering

## Product Information

### Valve Finder - Mechanically Actuated

Actuator	Model Number	Port Size	Flow (C <sub>v</sub> )	Return Flow	Flow Pattern	See Page
Straight Plunger	MV-5	1/8	0.11	Spring	3-Way	35-38
	MV-45	1/8	0.11	Spring	3-Way	35-38
	LTV-5	1/8	0.18	Int. Air	4-Way	31-34
	LTV-45	1/8	0.18	Int. Air	4-Way	31-34
	FC-51	1/8	0.81	Spring	3-Way	39-41
	3C-1	1/4	0.48	Spring	3-Way	39-41
	FC-101	3/8	1.15	Spring	3-Way	39-41
Straight Leaf	MV-10	1/8	0.11	Spring	3-Way	35-38
	MV-70	1/8	0.11	Spring	3-Way	35-38
	LTV-10	1/8	0.18	Int. Air	4-Way	31-34
Roller	MV-15	1/8	0.11	Spring	3-Way	35-38
	MV-90	1/8	0.11	Spring	3-Way	35-38
	MV-25, MV-30	1/8	0.11	Spring	3-Way	35-38
	MV-75	1/8	0.11	Spring	3-Way	35-38
	LTV-15	1/8	0.18	Int. Air	4-Way	31-34
	LTV-25, LTV-30	1/8	0.18	Int. Air	4-Way	31-34
	LTV-75	1/8	0.18	Int. Air	4-Way	31-34
One-Way Roller	MV-20	1/8	0.11	Spring	3-Way	35-38
	MV-80	1/8	0.11	Spring	3-Way	35-38
	LTV-20	1/8	0.18	Int. Air	4-Way	31-34
	LTV-80	1/8	0.18	Int. Air	4-Way	31-34
Extended Rod	MV-85	1/8	0.11	Spring	3-Way	35-38
	LTV-85	1/8	0.18	Int. Air	4-Way	31-34
Ball	MV-40	1/8	0.11	Spring	3-Way	35-38
	LTV-40	1/8	0.18	Int. Air	4-Way	31-34

## Product Information

## Valve Finder - Hand (Manually) Actuated

Actuator	Model Number	Port Size	Flow (C <sub>v</sub> )	Return Flow	Flow Pattern	See Page
Fingertip Lever	MV-50	1/8	0.11	Spring	3-Way	35-38
	LTV-50	1/8	0.18	Int. Air	4-Way	31-34
	N2-HL	1/4	1.00	Spring	4-Way	21-23
	FT-101	3/8	1.15	Spring	3-Way	39-41
	FT-4	1/8	0.16	Spring	4-Way	39-41
Low Stress	LTV-PBG(F)	1/8	0.18	Int. Air	3- or 4-Way	29-30
Straight Lever	C2-7	1/4	0.75	Spring	4-Way	24-26
	C5-7	1/2	3.17	Spring	4-Way	24-26
	C2-8	1/4	0.75	Hand	4-Way	24-26
	C5-8	1/2	3.17	Hand	4-Way	24-26
	4B-1	1/4	0.48	Hand	4-Way	39-41
Push Button & Palm	MV-140	1/8	0.11	Spring	3-Way	35-38
	LTV-125	1/8	0.18	Int. Air	4-Way	31-34
	LTV-140	1/8	0.18	Int. Air	4-Way	31-34
	PC-51	1/8	0.81	Spring	3-Way	39-41
	MV-MH	1/8	0.11	Spring	3-Way	35-38
	LTV-MH	1/8	0.18	Int. Air	4-Way	31-34
	MV-EH & MV-FH	1/8	0.11	Spring	3-Way	35-38
	LTV-EH & LTV-FH	1/8	0.18	Int. Air	4-Way	35-38
	MV-ES	1/8	0.11	Spring	3-Way	35-38
MV-EMS	1/8	0.18	Detent	3-Way	35-38	
Double Button	N2-PB	1/4	1.00	Button	4-Way	21-23
Knob (Push-Pull)	LTV-130	1/8	0.18	Knob	4-Way	31-34
	PC-51A	1/8	0.81	Knob	3-Way	39-41
	ACV-16	5/32	0.053	Knob	4-Way	91-92
	ACV-25	1/4	0.12	Knob	4-Way	91-92
Flip Toggle	MV-35	1/8	0.11	Toggle	3-Way	35-38
	LTV-35	1/8	0.18	Toggle	4-Way	31-34
Twist (2 Pos.)	MV-TP	1/8	0.11	Twist	3-Way	35-38
	LTV-TP	1/8	0.18	Twist	4-Way	31-34

## Product Information

### Valve Finder - Electrically Actuated

Actuator	Model Number	Port Size	Flow (C <sub>v</sub> )	Return Flow	Flow Pattern	See Page
Single Solenoid	LTV-115DD	1/8	0.18	Int. Air	4-Way	31-34
	N2-SCD	1/4	1.00	Spring	4-Way	21-23
	C2-4DCD	1/4	0.75	Spring	4-Way	24-26
	C5-4DCD	1/2	3.17	Spring	4-Way	24-26
	V1 (Isonic)	5/32 Tube	0.02	Spring	3-Way	6-9
	V2 (Isonic)	1/4 Tube	0.01, 0.02, 0.05	Spring or Ext. Air	3-Way	10-13
	V4 (Isonic)	1/4 Tube	0.8	Spring	4-Way	14-16
	MB12-3CSC	1/8	0.035	Spring	3-Way	85
	MB12-3USC	1/8	0.035	Spring	3-Way	85
	MC25-3CSC	1/4	0.035	Spring	3-Way	85
	MB12-3USC	1/4	0.035	Spring	3-Way	85
	MB12-2CSC	1/8	0.035	Spring	2-Way	85
	MB25-2CSC	1/4	0.035	Spring	2-Way	85
	Double Solenoid	LTV-120DD	1/8	0.18	Solenoid	4-Way
N2-DCD		1/4	1.00	Solenoid	4-Way	21-23
C2-5DCD		1/4	0.75	Solenoid	4-Way	24-26
C5-5DCD		1/2	3.17	Solenoid	4-Way	24-26
C2-6HDCD		1/4	0.75	Solenoid	4-Way	24-26
C2-6RDCD		1/4	0.75	Solenoid	4-Way	24-26



## Product Information

### Valve Finder - Air Actuated

Actuator	Model Number	Port Size	Flow (C <sub>v</sub> )	Return Flow	Flow Pattern	See Page
Single Pressure	LTV-60	1/8	0.18	Int. Air	4-Way	31-34
	LTV-60L	1/8	0.18	Int. Air	4-Way	31-34
	L-10	1/8	0.11	Int. Air	4-Way	27-28
	K-10	1/8	0.18	Int. Air	4-Way	27-28
	N2-SP	1/4	1.00	Spring	4-Way	21-23
	V4 (Isonic)	1/4 Tube	0.80	Spring	4-Way	14-16
	W-10	1/4	0.63	Int. Air	4-Way	27-28
	C2-3	1/4	0.75	Spring	4-Way	24-26
	C5-3	1/2	3.17	Spring	4-Way	24-26
	MV-60	1/8	0.11	Spring	3-Way	35-38
	MPE-BZ	1/8	-	Spring	Spec.	90
	MPE-BZE	1/8	-	Spring	Spec.	90
Double Pressure	LTV-110	1/8	0.18	Ext. Air	4-Way	31-34
	N-10	1/8	0.11	Ext. Air	4-Way	27-28
	M-10	1/8	0.18	Ext. Air	4-Way	27-28
	N2-DP	1/4	1.00	Ext. Air	4-Way	21-23
	V4 (Isonic)	1/4 Tube	0.80	Ext. Air	4-Way	14-16
	X-10	1/4	0.63	Ext. Air	4-Way	27-28
	C2-1	1/4	0.75	Ext. Air	4-Way	24-26
	C5-1	1/2	3.17	Ext. Air	4-Way	24-26
Single Bleed	T-10	1/8	0.11	Int. Air	4-Way	27-28
	O-10	1/8	0.18	Int. Air	4-Way	27-28
	Y-10	1/4	0.63	Int. Air	4-Way	27-28
	404A	1/8	-	Spring	2-Way	27-28
	405A	Spec.	-	Spring	2-Way	27-28
Double Bleed	V-10	1/8	0.11	Ext. Bleed	4-Way	27-28
	U-10	1/8	0.18	Ext. Bleed	4-Way	27-28
	Z-10	1/4	0.63	Ext. Bleed	4-Way	27-28
	N2-DB	1/4	1.00	Ext. Bleed	4-Way	21-23

### Valve Finder - Foot Actuated

Actuator	Model Number	Port Size	Flow (C <sub>v</sub> )	Return Flow	Flow Pattern	See Page
Pedal	2060400	1/4	0.11	Spring	3-Way	37
	N2-F4	1/4	1.00	Spring	4-Way	21-23
Foot Treadle	4W-1	1/4	0.48	Foot	4-Way	39-41
	201	3/8	1.15	Foot	3-Way	39-41

# Reference

## Product Information

### Special Applications

When you have a difficult or special application, Bimba welcomes the opportunity to design the right product for your application. The following are some of the applications where we have designed a product to solve a problem.



*Car Wash  
Equipment*

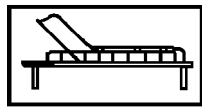

*Hospital  
Equipment*



*Printing  
Presses*

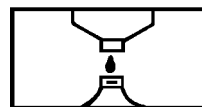

*Liquid Dispensing  
Applications*



*Sewing  
Machines*

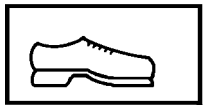

*Shoe Assembly  
Equipment*

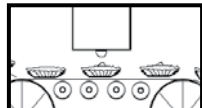

*Food Processing  
Equipment*



*Fuel Treatment  
Equipment*



*Dental  
Equipment*

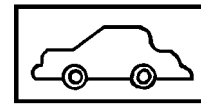

*Auto  
Assembly*

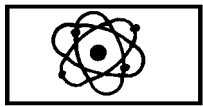

*Nuclear Fuel  
Refining*

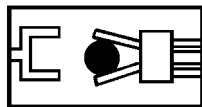

*Robotic  
Applications*



*Safety  
Equipment*



*Agricultural  
Equipment*

Contact Bimba today for help solving your special application needs.

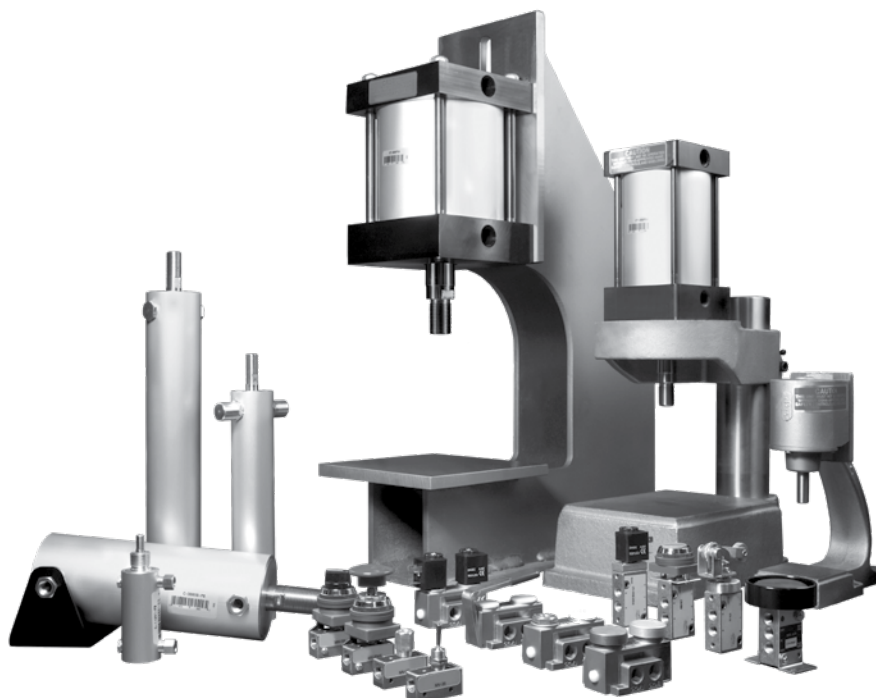



IMI Precision Engineering operates four global centres of technical excellence and a sales and service network in 75 countries, as well as manufacturing capability in the USA, Germany, China, UK, Switzerland, Czech Republic, Mexico and Brazil.

For information on all IMI Precision Engineering companies visit

[www.imi-precision.com](http://www.imi-precision.com)

**Supported by distributors worldwide.**



Due to our policy of continuous development, Bimba reserve the right to change specifications without prior notice.

BIM-CRVTC-0518

Selected Images used under license from Shutterstock.com

**Bimba**

25150 S. Governors Hwy  
University Park, IL 60484

Tel: +1 708 534 8544

Fax: +1 708 235 2014

For further information, scan this QR code or visit [www.bimba.com](http://www.bimba.com)

